

Panasonic

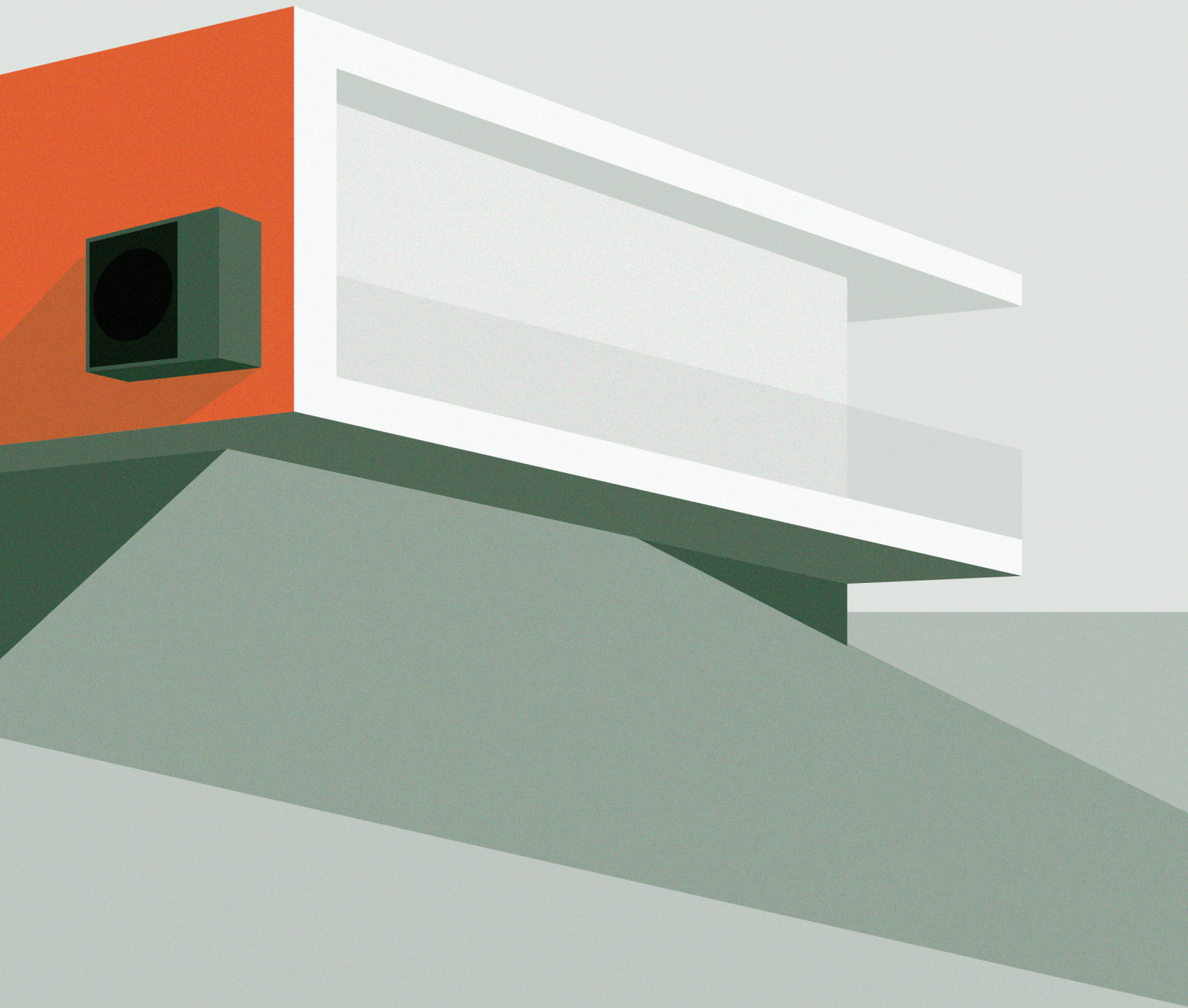

AQUAREA RANGE
2024 / 2025



AQUAREA

heating & cooling solutions

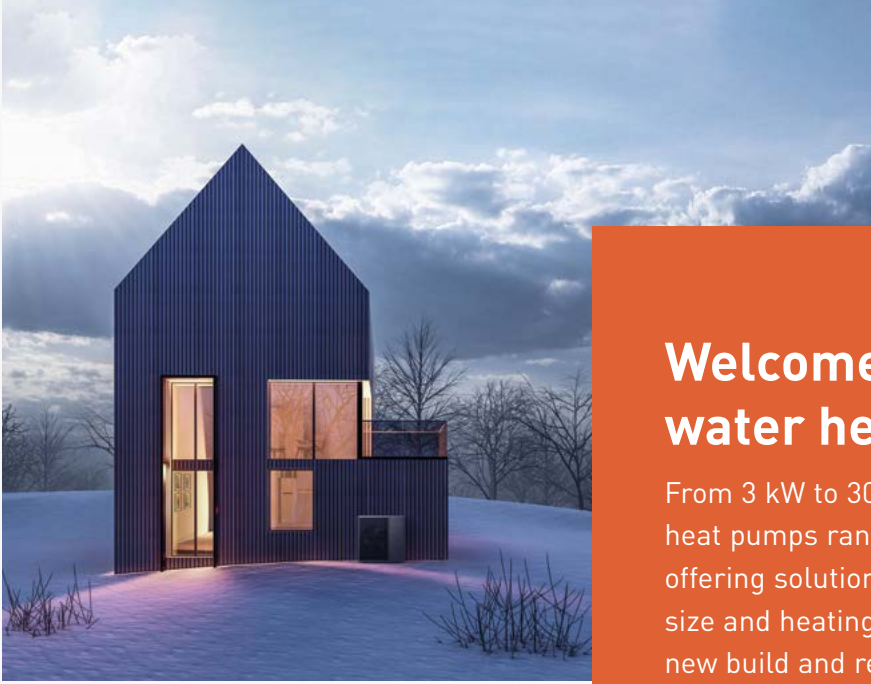

Welcome to Aquarea air to water heat pumps

From 3 kW to 30 kW, Panasonic's Aquarea air to water heat pumps range is one of the widest on the market, offering solutions for most properties, whatever their size and heating and cooling demands. Suitable for new build and refurbishment projects, the solutions are cost-effective with minimised environmental impact.

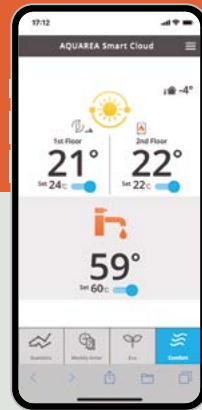



AQUAREA

Highlighted features	→ 22
Introducing the Panasonic Aquarea – air source heat pump	→ 24
Aquarea Heat Pump line-up	→ 26
Panasonic introduces Aquarea M, the 2nd Series of air to water heat pumps with R290	→ 28
Aquarea M Series	→ 30
Big Aquarea T-CAP M Series	→ 33
Big Aquarea for centralised heating and DHW installations	→ 34
Aquarea All in One Hydraulic M Series	→ 36
Aquarea K Series	→ 38
Aquarea EcoFlex	→ 40
Aquarea Smart and Service Cloud	→ 44
Control and connectivity	→ 46
Nearly Zero Energy Buildings (nZEB)	→ 48
Aquarea and PV integration	→ 49
Panasonic PRO Club	→ 50
Aquarea Designer - online tool	→ 51
Aquarea Hydraulic	→ 52
Aquarea Split	→ 53

Aquarea High Performance

Hydraulic L Series · R290	→ 54
Mono-bloc J Series · R32	→ 56
Mono-bloc H Series · R410A	→ 57
All in One K Series · R32	→ 63
All in One K Series 2 zones · R32	→ 65
All in One K Series with Electrical Anode · R32	→ 66
All in One Compact H Series · R410A	→ 68
All in One H Series · R410A	→ 69
Bi-bloc K Series · R32	→ 70
Bi-bloc H Series · R410A	→ 72

Aquarea EcoFlex

Aquarea EcoFlex · R32	→ 61
-----------------------	------

Aquarea T-CAP

Hydraulic M Series · R290	→ 58
Mono-bloc J Series · R32	→ 60
All in One K Series · R32	→ 73
All in One K Series with Electrical Anode · R32	→ 74
All in One H Series · R410A	→ 75
All in One H Series. Super Quiet outdoor unit · R410A	→ 76
Bi-bloc K Series · R32	→ 77
Bi-bloc H Series · R410A	→ 78
Bi-bloc H Series. Super Quiet outdoor unit · R410A	→ 79

Fan coils units	→ 80
Smart fan coils	→ 81
Fan coil comfort AC fan	→ 82
Fan coil comfort EC fan	→ 84
Fan coil wall AC fan	→ 86
Sanitary tanks	→ 88
Heat recovery ventilation unit	→ 90
Counter flow ventilation	→ 92
DHW Stand-alone	→ 94
Accessories and control	→ 96
Heating and cooling capacity tables	→ 100
Examples of installations	→ 109

Highlighted features

Panasonic's Aquarea range of heat pumps deliver major energy savings thanks to its incredible efficiency even at -20 °C. The Panasonic Aquarea Heat Pumps are designed and produced by Panasonic and not by other companies.



Panasonic Aquarea Heat Pumps are part of a new generation of heating solutions that use a renewable, free energy source (air) to heat or cool the home and produce hot water by transferring heat rather than generating it.

The heat pump is one of the technologies listed on the International Energy Agency's (IEA) Blue Map, which aims to reduce CO₂ emissions to half of 2005 levels by 2050.

Energy saving



Natural refrigerant R290 with GWP 3.

Natural refrigerant R290 has low Global Warming Potential (GWP) of just 3, helping reduce CO₂ emissions and environmental impact.



Refrigerant R32.

Our heat pumps containing R32 refrigerant show a drastic reduction in the value of Global Warming Potential (GWP).



Better efficiency and value for medium temperature applications.

ErP 55°C

Energy efficiency class up to A++ in a scale from A+++ to D.



ErP 35°C

Better efficiency and value for low temperature applications.

Energy efficiency class up to A+++ in a scale from A+++ to D.



DHW

Better efficiency and value for domestic hot water.

Energy efficiency class up to A+ in a scale from A+ to F.



INVERTER+

Inverter Plus system.

Inverter Plus system classification highlights Panasonic's highest performing systems.



A CLASS WATER PUMP

AUTO SPEED

A class water pump.

Aquarea are built-in with A class energy efficiency water pump. High efficiency circulating the water in the heating installation.



ErP

ERP 2018.

Compliant following COMMISSION REGULATION (EU) No2016/2281.



EC MOTOR GREEN VENTILATION

EC motor green ventilation.

Range of fan coils with improved efficiency and optional EC fan motors.

High performance and indoor air quality



5.33 COP HIGH PERFORMANCE

Aquarea High Performance for low consumption houses.

From 3 to 16 kW. For a house with low temperature radiators or under-floor heating, our high performance Aquarea HP is a good solution. * COP of 5,33 for 3 kW K series.



-20°C CONSTANT HEATING T-CAP

Aquarea T-CAP for extremely low temperatures.

From 9 to 16 kW. It can work at outdoor temperatures as low as -28 °C and maintain the rated capacity down to -20 °C.



DHW

DHW.

With Aquarea Heat Pumps, DHW can be produced efficiently, achieving high DHW COP of 3,6 with the L Series All in One indoor unit.



-20°C HEATING MODE

Down to -20 °C in heating mode.

The heat pumps operate in heating mode with an outside temperature down to -20 °C.



WATER FILTER WITH MAGNET

Water filter with magnet.

Easy access and fast clip technology for J Series onwards. Water filter only for H Series.



75°C OUTPUT WATER FLOW TEMPERATURE

75 °C output water.

Reaches water outlet temperature up to 75 °C for L and M Series.



65°C OUTPUT WATER FLOW TEMPERATURE

65 °C output water.

Reaches water outlet temperature up to 65 °C.



FLOW SENSOR

Water flow sensor.

Included on H Series onwards.



5 YEARS COMPRESSOR WARRANTY

5 Years compressor warranty.

We guarantee the outdoor unit compressors in the entire range for five years.

High connectivity



BOILER CONNECTION

Renovation.

Our Aquarea Heat Pumps can be connected to an existing or new boiler for optimum comfort even at very low outdoor temperatures.



SOLAR KIT

Solar kit.

For even greater efficiency, Aquarea Heat Pumps can be connected to photovoltaic solar panels with the optional PCB.



ADVANCED CONTROL

Advanced control.

Remote controller with full dotted 3,5" wide back light screen. Menu with 17 available languages easy to use for installer and user. Included on H Series onwards.



INTERNET CONTROL

Internet control.

The Panasonic Comfort Cloud App allows users to conveniently manage and monitor Panasonic residential heat pumps from a mobile device, anytime, anywhere.



BMS CONNECTIVITY

BMS connectivity.

Aquarea Heat Pumps offer seamless integration into a Building Management System (BMS) using an optional gateway.



SG Ready



Q



APPROVED PRODUCT



MCS



CERTIFIED CORPORATION

Aquarea H and J Series heat pumps in combination with the optional PCB CZ-NSP4 hold the SG Ready Label (Smart Grid Ready Label), given by Bundesverband Wärmepumpe (German Heat Pump Association). This Label shows the real capacity of Aquarea to be connected in an intelligent grid control.

MCS Certificate number: MCS HP0086*. Keymark: Check all our certified heat pumps on: www.heatpumpkeymark.com. Passive House Institute: Certified models can be checked in <https://database.passivehouse.com>.

* Not all products certified. As the certification process is on-going and the list of certified products constantly changing, please check for latest details on the official websites.

Warning on quality of water and groundwater use: This product is designed to comply with the European drinking water standard (EU) 2020/2184. The lifespan of the product is not guaranteed in the case of the use of groundwater, such as spring water or well water, the use of tap water when salt or other impurities are contained, nor in areas of acidic water quality. Maintenance and warranty costs related to these cases are the customer's responsibility.

Introducing the Panasonic Aquarea – air source heat pump

At the forefront of energy innovation, Aquarea is resolutely positioned as a “green” heating and air conditioning solution.

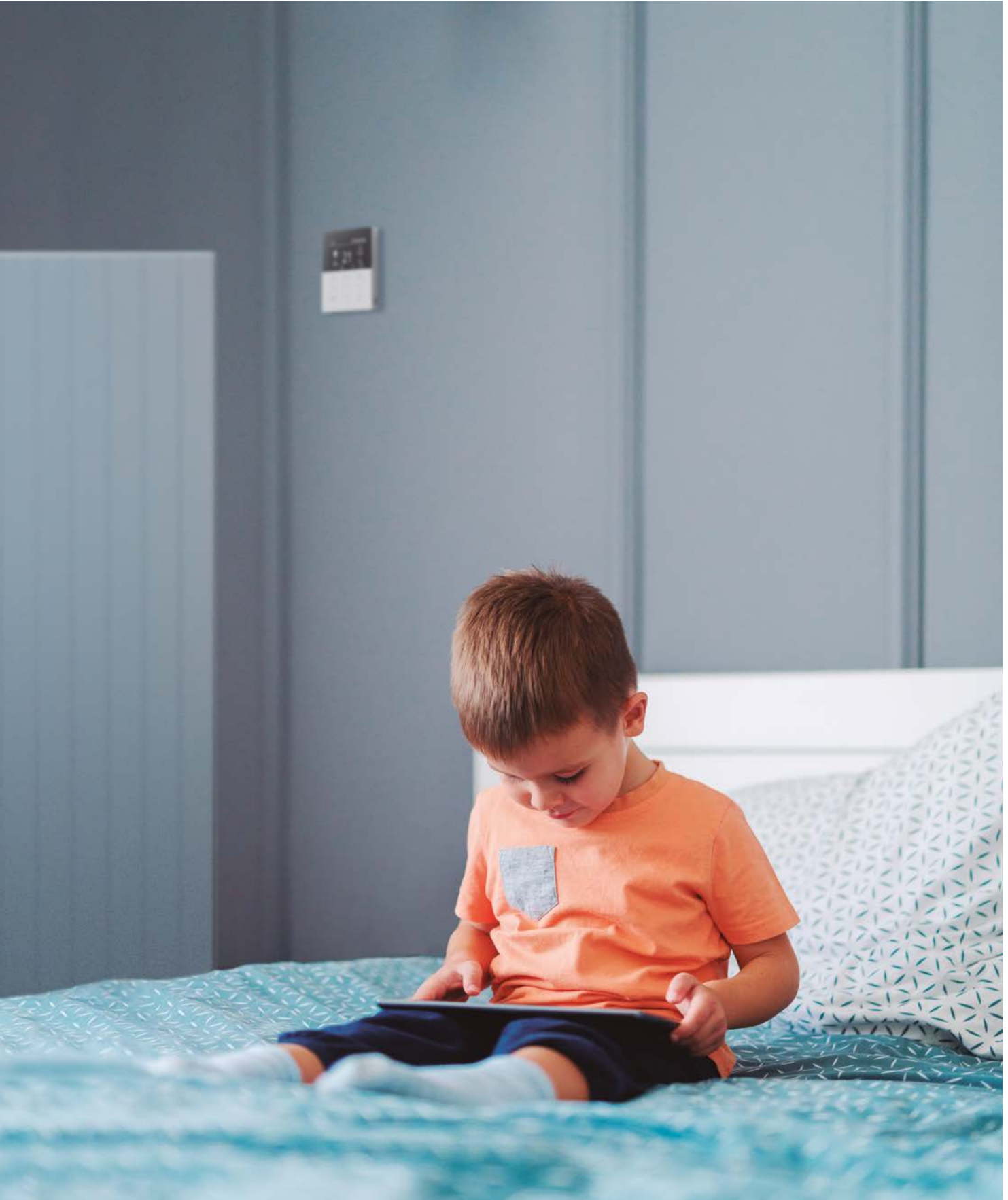

Introducing the Panasonic Aquarea – air source heat pump.

In European households, 79%* of energy consumption comes from heating and producing domestic hot water. By converting heat energy in the air into household warmth, highly efficient Aquarea technology reduces CO₂ emissions and environmental impact, compared to conventional boilers and electric heaters. Compared to an electric heater, the Aquarea Heat Pumps offer up to five times the output in kilowatts per every input in kilowatts.

* ec.europa.eu/eurostat

Up to 80%* energy savings with Aquarea

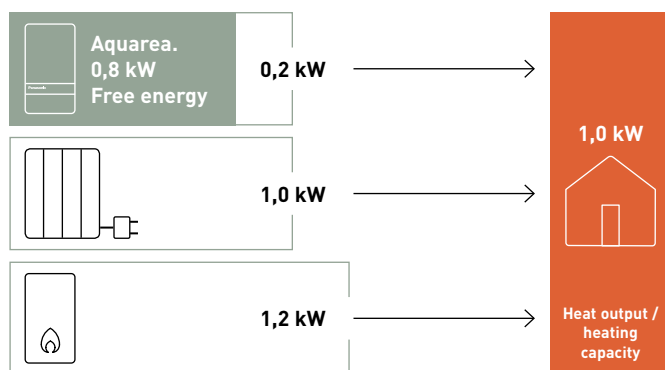

Power input / energy consumption power. * 35 °C flow temperature.



Why Panasonic Aquarea air source heat pumps?

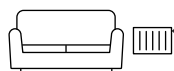

Optimum solutions for premium comfort.

Panasonic Aquarea Heat Pumps warm your home effectively and efficiently.

- Precise indoor temperature control thanks to reliable Panasonic Inverter compressors
- Aquarea also offers cooling in summer and provides hot water all year round
- The Quiet mode that can further reduce the noise levels by up to 8 dB(A)¹⁾
- Aquarea T-CAP heat pumps can work in outdoor temperatures as low as -28 °C (for All in One and Bi-bloc)
- Energy savings, comfort and convenient control from any location thanks to the Panasonic Comfort Cloud App
- Aquarea Service Cloud enables remote maintenance of the system

* For K Series onwards.

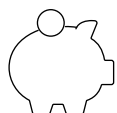

Energy saving means money savings.

Panasonic Aquarea Heat Pumps are a smart choice for saving in heating, all leading to large savings in electricity bills.

- Savings of up to 80% on heating expenses, compared to electrical heaters
- Up to A+++ in heating, within the range of A+++ to D, and A+ in domestic hot water, in the range of A+ to F
- Energy consumption can be further reduced by connecting photovoltaic panels to the system
- In combination with a ventilation solution, the indoor air becomes cleaner and the heating requirements of the building are reduced



Adapts to your needs.

Panasonic Aquarea Heat Pumps produce heating, cooling and domestic hot water with a single system.

- From 3 kW to 30 kW, there is always an option for lower initial investment and operational costs
- Aquarea can be connected to floor heating, radiators or fan coil units
- In refurbishment projects, Aquarea can be integrated in existing heating systems
- Providing water outlet temperatures of up to 75 °C down to -10 °C¹⁾
- Large piping length of up to 50 m between indoor and outdoor
- Aquarea T-CAP heat pumps guarantee the capacity without backup heating down to -20 °C²⁾

1) Aquarea L and M Series. 2) At 35 °C flow temperature.



Contributing to a decarbonised society.

The heat pump is considered a 'green' choice as the heat energy is taken from the environment, making it a sustainable option.

- It maintains a comfortable indoor temperature while significantly reducing environmental burden
- All Aquarea Heat Pumps can also be connected to a solar thermal or PV system in order to increase efficiency and minimise environmental impact
- Aquarea L and M Series heat pumps are engineered with natural refrigerant R290 with GWP 3

Aquarea Heat Pump line-up

Aquarea hydraulic systems.

The Aquarea hydraulic system allows for easier installation as there are only water pipes between the indoor unit and the inside of the building. As the outdoor unit is hermetically sealed, no F-gas certification is required for installation or commissioning. The hydraulic system is offered in a hydrosplit version, consisting of an outdoor and indoor unit (either All in One or Bi-bloc) connected by water pipes. Alternatively, a stand-alone outdoor unit can be directly connected to the heating and/or hot water system.

Aquarea split systems.

The Aquarea split system consists of a separate outdoor unit and indoor unit connected by refrigerant pipes. There is no requirement for antifreeze protection of the piping located outside the building, even if the system is inactive for an extended period. The split system is available in two types of indoor units: All in One and Bi-bloc.

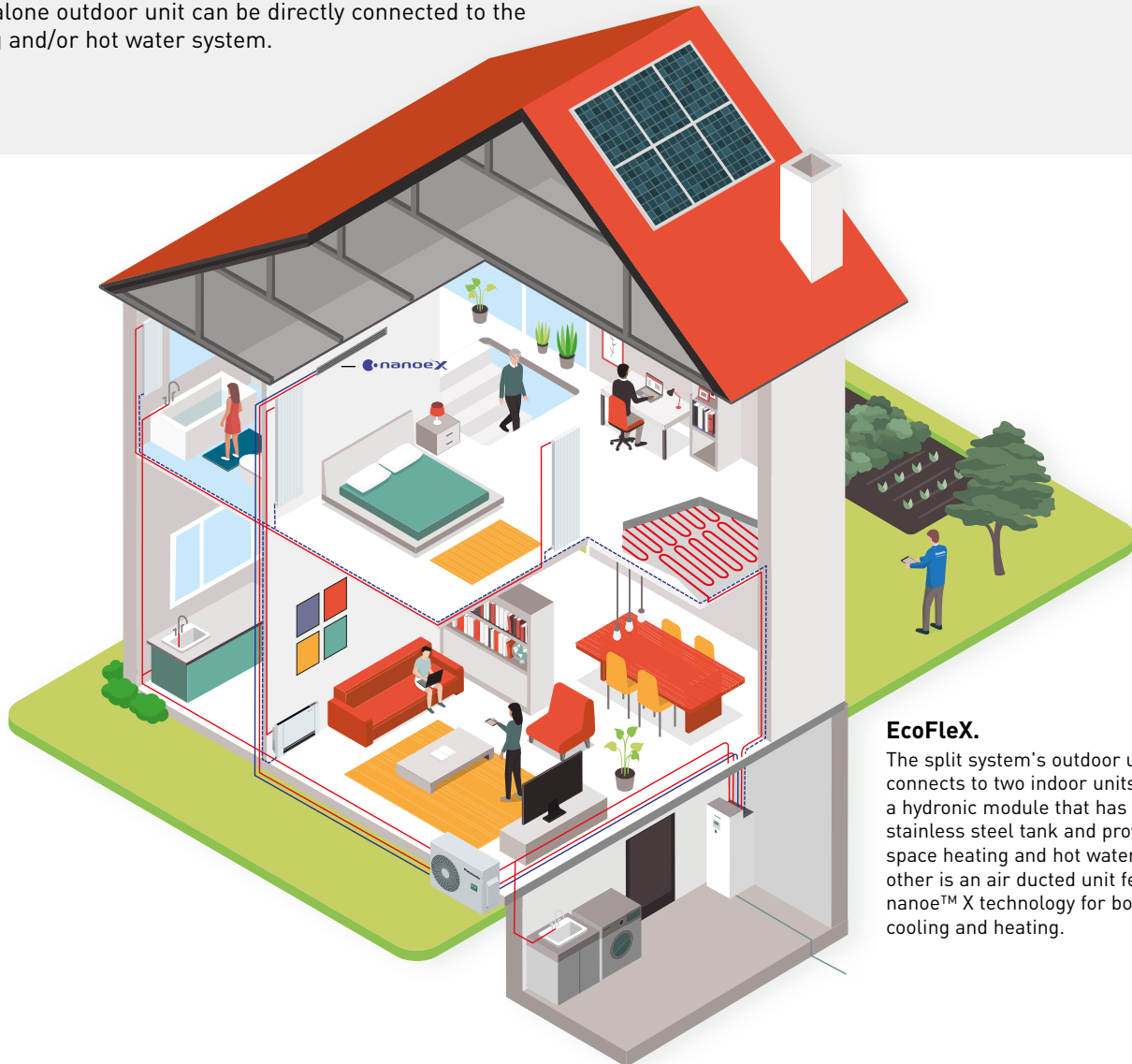

EcoFleX.

The split system's outdoor unit connects to two indoor units. One is a hydronic module that has a 185 L stainless steel tank and provides space heating and hot water. The other is an air ducted unit featuring nanoe™ X technology for both cooling and heating.

All in One indoor unit.

The All in One unit simplifies the installation by combining the indoor unit and a stainless steel tank into a compact, space-saving unit.

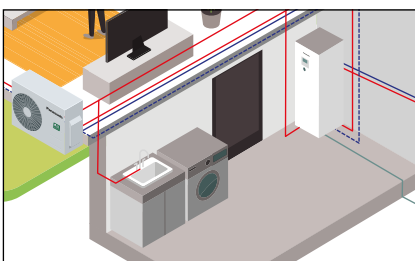

Bi-bloc indoor unit.

This wall-mounted indoor unit provides great installation flexibility as the size of the tank can be chosen based on installation requirements.

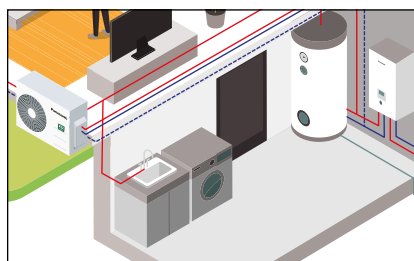

Stand-alone outdoor unit.

This hydraulic system operates without an indoor unit, providing a high level of installation flexibility. This solution is particularly suitable for retrofit projects.

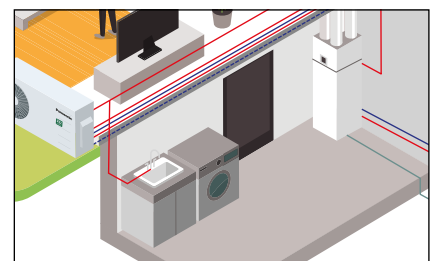







Panasonic Aquarea provides the ideal solution for any project, enhancing the efficiency of homes and simplifying the installation process.

Aquarea EcoFleX

For new installations, specially those with limited spaces.

Aquarea EcoFleX is a groundbreaking heat pump that connects an air ducted unit with nanoe™ X technology providing heat recovery hot water, space heating, space cooling and cleaner air. Outstanding efficiency and energy savings with low CO₂ emissions.

					
Heating - Cooling - DHW.	Radiators - Underfloor heating - DHW - Air conditioning.	New buildings.	ErP class (heating 35 °C / 55 °C) ¹⁾ .	Wi-Fi included.	Smart Grid ready ²⁾ .

Aquarea High Performance

For new installations and low consumption homes.

Suitable for a wide range of properties that demand exceptional efficiency and high energy savings. Featuring COPs as high as 5,33 ¹⁾ and water outlet temperatures of up to 75 °C ²⁾, this solution is perfect for either underfloor heating or radiators.

1) K and J Series 3 kW. 2) L Series.

					
Heating - Cooling - DHW.	Radiators - Fan coil - Underfloor heating - DHW.	New buildings and retrofit.	ErP class (heating 35 °C / 55 °C) ¹⁾ .	Wi-Fi ready (included in L Series).	Smart Grid ready ²⁾ .





System	Hydraulic			Split	
Series · Refrigerant	L · R290	J · R32	H · R410A	K · R32	H · R410A
Minimum outdoor temperature	-25 °C	-20 °C	-20 °C	-25 °C	-20 °C
Maximum water outlet temperature	75 °C	60 °C	55 °C	60 °C	55 °C
Maximum DHW temperature	65 °C without heater ³⁾	65 °C ⁴⁾	65 °C ⁴⁾	65 °C ⁴⁾	65 °C ⁴⁾
Type	All in One - Bi-bloc	Mono-bloc	Mono-bloc	All in One - Bi-bloc	All in One - Bi-bloc
Line-up	5, 7, 9 kW (1ph)	5, 7, 9 kW (1ph)	12, 16 kW (1ph)	3, 5, 7, 9, 12 kW (1ph) 9, 12, 16 kW (3ph)	12, 16 kW (1ph) 9, 12, 16 kW (3ph)

Aquarea T-CAP

For extremely low temperatures and retrofit.

Aquarea T-CAP can maintain the rated heating capacity even at -20 °C ¹⁾ outdoor temperature, without requiring an electrical heater. This makes it an ideal solution for locations with extremely low temperatures. It is also suitable for retrofit projects as it can achieve water outlet temperatures of up to 75 °C ²⁾.

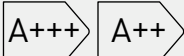
1) At 35 °C flow temperature. 2) M Series.

					
Heating - Cooling - DHW.	Radiators - Fan coil - Underfloor heating - DHW.	Extreme cold ambient and retrofit.	ErP class (heating 35 °C / 55 °C) ¹⁾ .	Wi-Fi ready (included in M Series).	Smart Grid ready ²⁾ .

System	Hydraulic		Split	
Series · Refrigerant	M · R290	J · R32	K · R32	H · R410A
Minimum outdoor temperature	-28 °C	-20 °C	-28 °C	-28 °C
Maximum water outlet temperature	75 °C	65 °C ⁵⁾	65 °C	60 °C
Maximum DHW temperature	65 °C without heater ³⁾	65 °C ⁴⁾	65 °C ⁴⁾	65 °C ⁴⁾
Type	All in One - Bi-bloc - Stand-alone outdoor	Mono-bloc	All in One - Bi-bloc	All in One - Bi-bloc
Line-up	9, 12 kW (1ph) 9, 12, 16, 20, 25, 30 kW (3ph)	9, 12 kW (1ph) 9, 12, 16 kW (3ph)	9, 12 kW (1ph) 9, 12, 16 kW (3ph)	9, 12 kW (1ph) 9, 12, 16 kW (3ph)

The information in this page is applicable in most of models in each line up, check product specifications to confirm by model. 1) Scale from A+++ to D. 2) With optional PCB CZ-NS*P. 3) For L Series, at -10 °C or higher. For M Series, at -15 °C or higher. 4) DHW maximum temperature with heater. 5) It is possible to set temperature by 65 °C on remote controller. Normally, outlet water temperature is 60 °C or lower. In case of ΔT setting with remote controller is 15 °C and the outdoor ambient temperature is 5 to 20 °C, outlet water temperature 65 °C is possible.

Panasonic introduces Aquarea M, the 2nd Series of air to water heat pumps with R290

Aquarea air to water heat pumps with R290 refrigerant range is a groundbreaking low energy system for heating, cooling and domestic hot water production that delivers outstanding performance, aligning with our vision of a carbon-free society and our GREEN IMPACT plan.



Global Warming Potential

With sustainability at the forefront of its innovations, Panasonic's newest series are engineered with industry leading natural refrigerant R290, which has a low Global Warming Potential (GWP) of just 3, helping reduce CO₂ emissions and environmental impact.

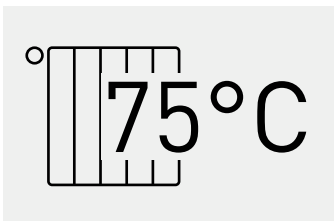

Output water.

Up to 75 °C water outlet down to -15 °C* outdoor.

* -10 °C for L Series.

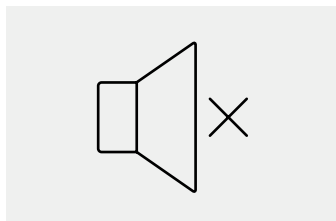

Quiet operation.

Only 27 dB(A) sound pressure at 5m*.

* Sound pressure calculation for WH-WDG05LE5, free standing, A +7 °C, W 35 °C in Quite mode 3.

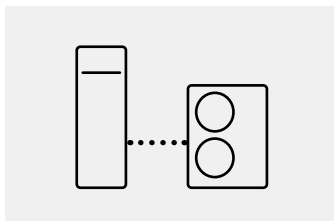

Flexible hydraulic installation.

Hydraulic connection between indoor and outdoor.

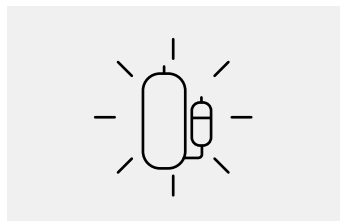

Made and designed by Panasonic.

Reliable outdoor units with Panasonic compressor.

Output water. High performance under extreme conditions

Excellent solution for heating system retrofit.

The compressor operates without backup heating down to -28 °C ambient temperatures, and can be integrated alongside existing radiators with a high-water flow temperature of up to 75 °C at -15 °C outside temperature. Even at -28 °C outside temperature, it can supply hot water at 55 °C.

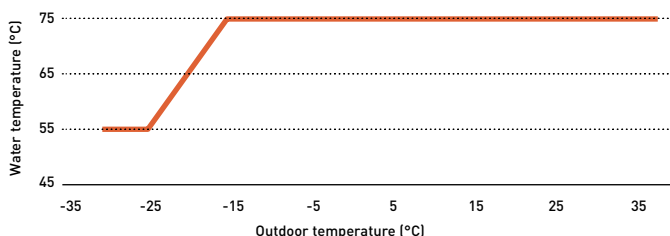

* For M Series. In case of L Series operation down to -25 °C and 75 °C water outlet down to -10 °C ambient.

Sterilisation process without heater.

It can also reach a domestic hot water temperature of up to 65 °C without the use of the electric heater, so the tank sterilization can be performed with the heat pump operation.

Quiet operation. Panasonic's unique low noise architecture

The compressor, which is a major source of noise, is equipped with a double-bottomed structure to provide a safe, quiet structure that does not disturb neighbours in crowded residential areas.

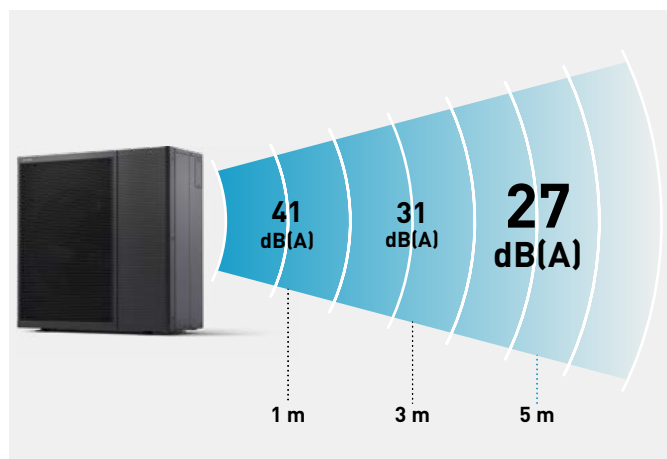

* Sound pressure calculation for WH-WDG05LE5, free standing, A +7 °C, W 35 °C in Quite mode 3.



Flexible hydraulic installation

The installation of the system is 100% hydraulic, with only water pipes between the outdoor unit and the interior of the home.

More living space at home.

No indoor safety measures needed for refrigerant or fuel gas piping.

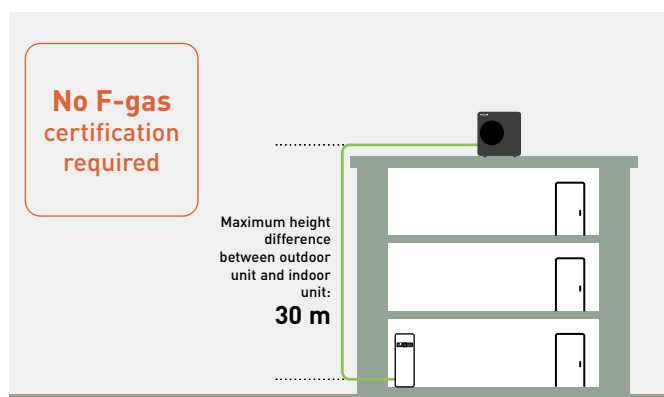

* For L Series only when the outdoor unit is installed above the indoor unit, and the water pressure does not exceed 1 bar at the outdoor unit.

Made and designed by Panasonic.

Aquarea High Performance L Series from 5 to 9 kW.



Aquarea T-CAP M Series from 9 to 30 kW.

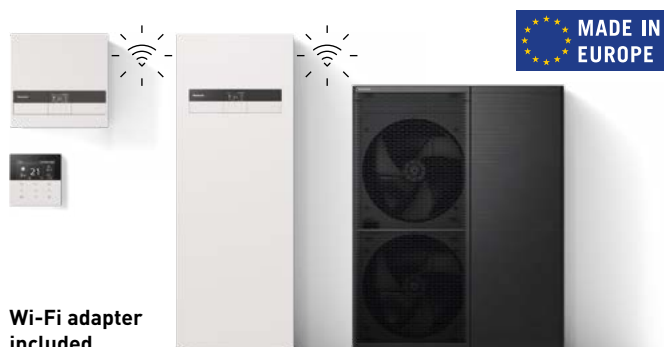

* Check availability of units and combinations.

Aquarea M Series, the modular heat pump concept of Panasonic

Introducing M Series T-CAP, the latest generation of Aquarea air to water heat pumps with R290.

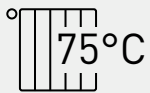

Output water.

Up to 75 °C water outlet down to -15 °C outdoor.



Quiet operation.

Only 29 dB(A) sound pressure at 5 m*.

* Sound pressure calculation for WH-WXG12ME5, free standing, A +7 °C, W 35 °C in Quite mode 3.

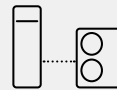

Flexible hydraulic installation.

Hydraulic connection between indoor and outdoor.



Made and designed by Panasonic.

Reliable outdoor units with Panasonic compressor.



Panasonic Comfort Cloud App and Aquarea Service Cloud included.

Smart control and maintenance.

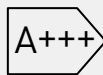

High efficiency.

ErP 35 °C. Energy efficiency class up to A+++*.

* Scale from A+++ to D.

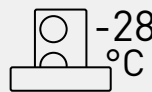

Extreme conditions.

Compressor operating down to -28 °C outdoor temperatures.

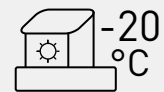

T-CAP.

Keeping heating capacity down to -20 °C.

Flexible installation, suitable for retrofit and new buildings.



Thanks to its new, modular concept, the outdoor unit can function independently with just an indoor remote control, for those seeking basic functionalities. Homeowners can opt for enhanced functionality by incorporating the more advanced control module or selecting between a Bi-bloc or All in One indoor units.



	Remote controller	Control module	Bi-bloc	All in One
CN-CNT	✓ [1]	✓ [2]	✓ [2]	✓ [2]
Backup heater	—	Field supply	✓	✓
Expansion vessel (10 L)	—	—	✓	✓
Additional functions	—	CZ-NS7P	CZ-NS6P	CZ-NS6P

Output water. High performance under extreme conditions

Excellent solution for heating system retrofit.

The compressor operates without backup heating down to -28 °C ambient temperatures, and can be integrated alongside existing radiators with a high-water flow temperature of up to 75 °C at -15 °C outside temperature. Even at -28 °C outside temperature, it can supply hot water at 55 °C.

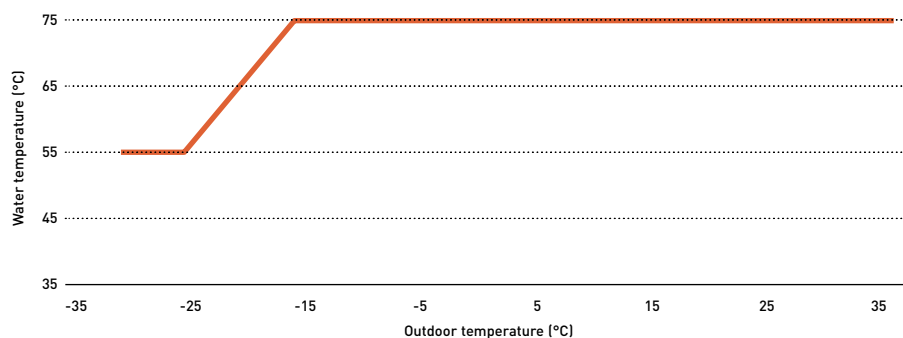

Quiet operation. Panasonic's unique low noise architecture

The compressor, which is a major source of noise, is equipped with a double-bottomed structure to provide a safe, quiet structure that does not disturb neighbours in crowded residential areas.

* Sound pressure calculation for WH-WXG12ME8, free standing, A +7 °C, W 35 °C in Quite mode 3.

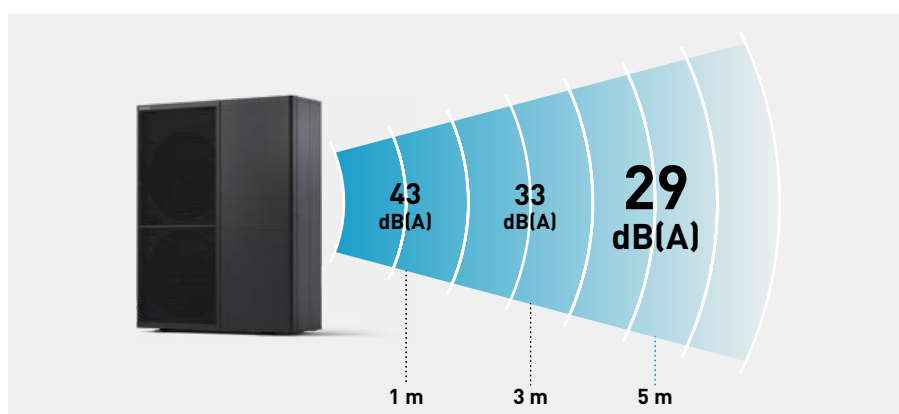

Aquarea T-CAP, high performance whatever the climate

With Aquarea T-CAP technology and the new compressor with Injection technology, Panasonic heat pumps can work in outdoor temperatures as low as -28 °C and maintain capacity without backup heating at -20 °C*.

1) 35 °C flow temperature.

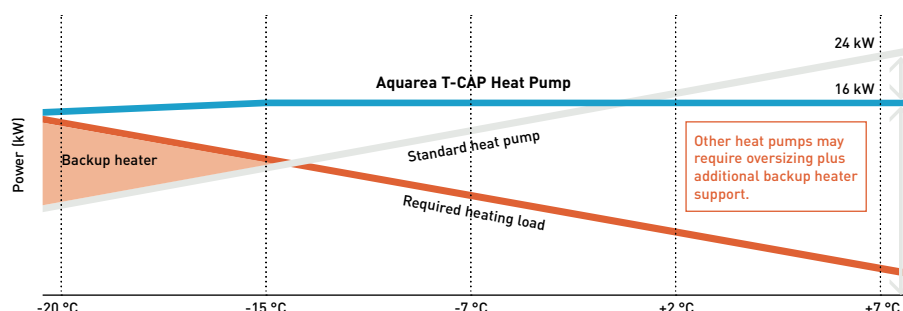

Aquarea M Series, the latest generation of Aquarea air to water heat pumps with R290.

Aquarea T-CAP M Series delivers a revolution in the design, performance, connectivity, and sustainability. Aligning with our vision of a carbon-free society and our GREEN IMPACT plan.



High energy efficiency in heating and domestic hot water

The Aquarea M Series saves energy and significantly reduces operating cost by achieving the highest ErP energy rating.

Aquarea M Series can reach a domestic hot water temperature of up to 65 °C without the use of the electric heater, so the tank sterilization can be performed with the heat pump operation for further energy savings.

* Rating conditions: Heating: Inside air temperature: 20 °C Dry Bulb / Outside air temperature: 7 °C Dry Bulb / 6 °C Wet Bulb. Conditions: Water input temperature: 30 °C / Water output temperature: 35 °C. Energy rating for WH-WXG12ME8.

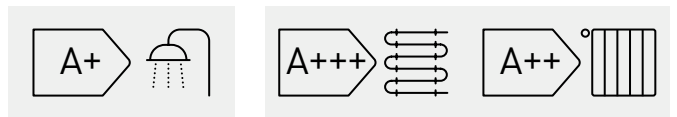

Energy efficiency class up to A+.
Scale from A+ to F.

ErP 35 °C / 55 °C.
Energy efficiency class up to A+++/A++.
Scale from A+++ to D.

Maximising hot water comfort

- Up to 40% more tap water with a higher tank temperature setting to save space
- New domestic hot water circulation mode for instant availability of hot tap water
- During sterilisation, the domestic hot water circulation mode is activated to ensure sterilisation of the water pipes

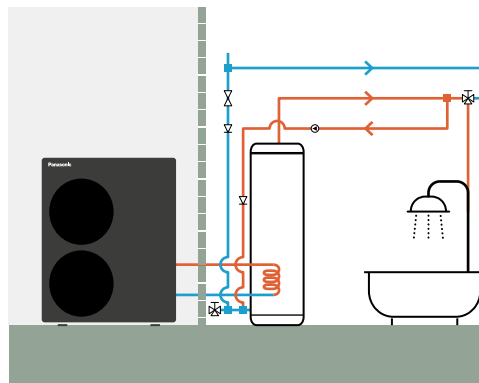

The hot water in the pipes recirculates back to the tank at set intervals during the set time period, ensuring instant hot water for the end user.

Internet adapter included for Smart Control and remote maintenance

The Aquarea M Series comes standard with an internet adapter for Wi-Fi or WLAN connection. It can be easily connected via the front panel of the indoor units or the control module, providing flexible and intuitive connectivity.



Reliable technology.

The outdoor units are equipped with a Panasonic R290 scroll compressor. The compressor is manufactured in-house with T-CAP technology including injection. The outdoor heat exchanger is protected with a Bluefin treatment for harsh ambient conditions.

Great serviceability

Cutting-edge outdoor unit design keeps the PCB in a safe and accessible location.

Aquarea M Series safety optimisation.

- 1 | Non-flammable control box
- 2 | Power box cable gland with sealed connections
- 3 | Air/refrigerant separator

* This image applies to 9, 12 and 16 kW.

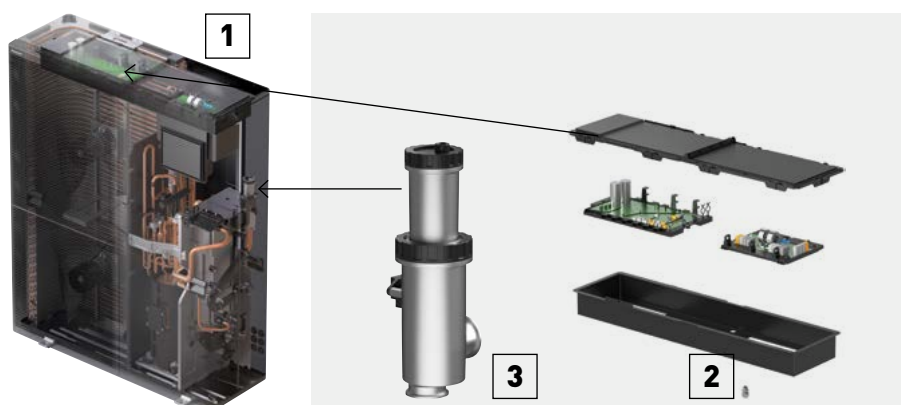

Big Aquarea T-CAP M Series, the ideal solution for centralised heating and DHW installations.

The new Big Aquarea M Series offers a flexible, compact and energy-efficient solution for central heating and/or domestic hot water installations in multi-family or commercial buildings.

The solution is suitable for both new buildings and retrofits, as it offers a sustainable alternative to traditional fossil fuel heating systems and it can be easily integrated with existing water system such as fan coils, floor heating or domestic hot water tanks.

<p>300 kW</p>		<p>55 °C</p>			<p>65 °C</p>
<p>Up to 300 kW in cascade.</p>	<p>Compact solution with small footprint.</p>	<p>Keeping capacity at 55 °C water outlet down to -15 °C outdoor.</p>	<p>Quiet operation.</p>	<p>Panasonic Inverter compressor.</p>	<p>DHW at 65 °C with compressor only.</p>

- Units from 20 to 30 kW, up to 300 kW in cascade
- Easy replacement of other heating sources
- Flexible control options: remote control only or control module for enhanced functionality
- Seamless Modbus integration
- Designed to blend with architecture and environment



Maintained capacity.
Time-saving installation.
Cost-saving.
Space-saving.

<p>2x 20 kW heat pump</p> <p>Conventional cascade system</p>		<p>1x 30 kW Big Aquarea T-CAP</p> <p>New Panasonic Aquarea T-CAP M Series</p>
------------------------------------------------------------------	--	-----------------------------------------------------------------------------------

For 30 kW demand at 55 °C water outlet and -7 °C outdoor temperature.

Big Aquarea for centralised heating and DHW installations in multi-family or commercial buildings

The new Big Aquarea M Series offers a flexible, compact and energy-efficient solution for central heating and/or domestic hot water installations in multi-family or commercial buildings.

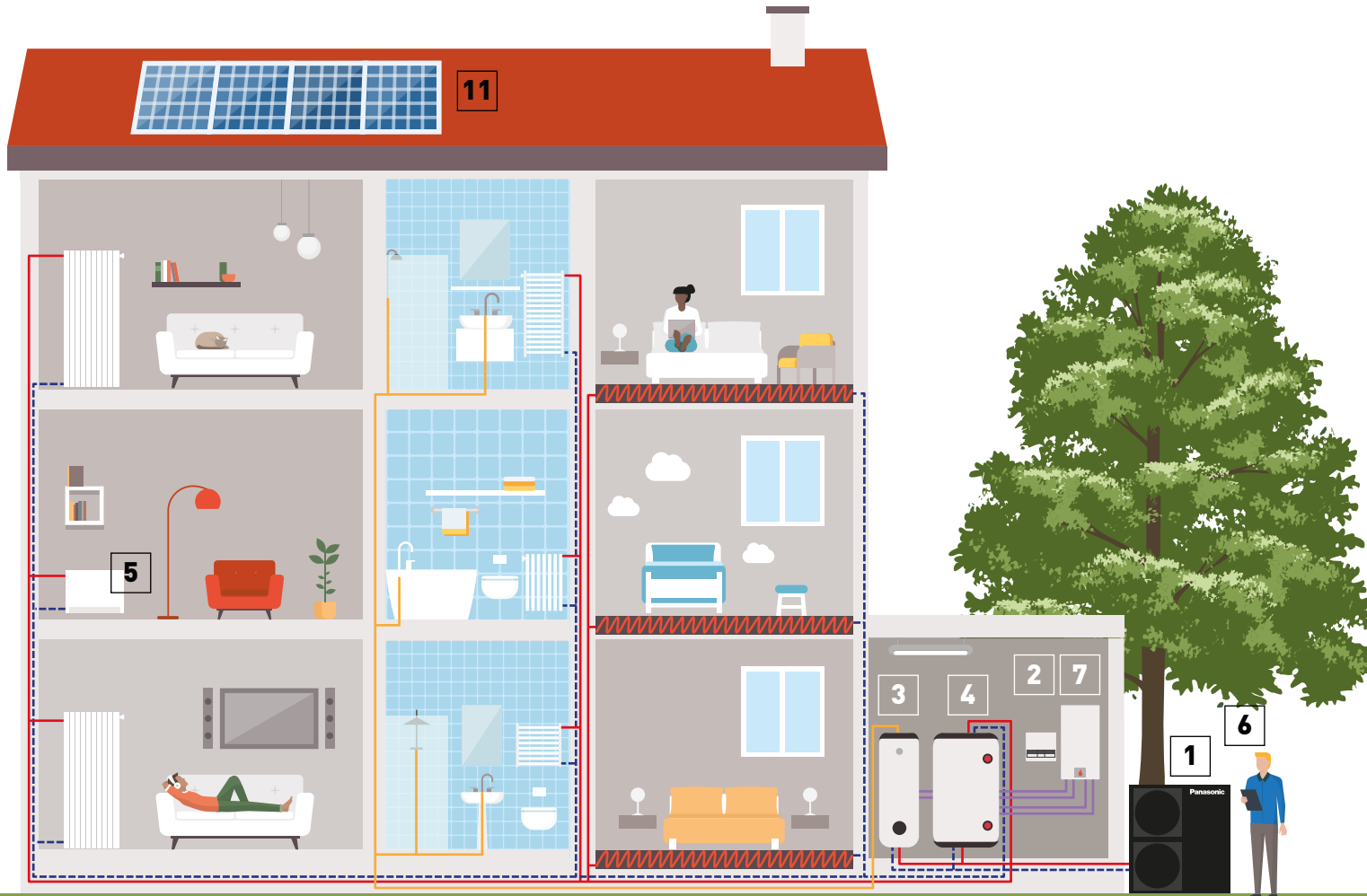

1
Big Aquarea T-CAP M Series.
25 kW heat pumps in cascade, for a space-saving solution. It can replace an old fossil fuel boiler.



2
M Series control module.
The control module allows for enhanced control functionality. Operation with the remote controller only is also possible.



3
High efficiency DHW tank.
A high efficiency tank provides the required volume of hot water, at the correct temperature, reducing energy costs.



4
Buffer tank.
Aquarea Heat Pumps can be integrated into a new or existing water system.



5
Fan coils, radiators or floor heating.
Aquarea Heat Pumps can be integrated into a new or existing water system.



6
Aquarea Smart and Service Cloud.
This IoT solution provides powerful and user-friendly management and monitoring of Aquarea Heat Pumps and enables remote maintenance.

A revolution in the design, performance, connectivity, and sustainability.

- Scalable solution, up to 300 kW in cascade
- Suitable for new build and retrofit
- Up to 75 °C water outlet down to -15 °C
- Easy replacement of other heating sources and integration into existing water systems
- Quiet operation
- Maintains output at 55 °C down to -15 °C
- Hot water production at 65 °C with compressor only
- Flexible control options and seamless Modbus integration

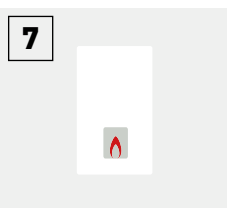
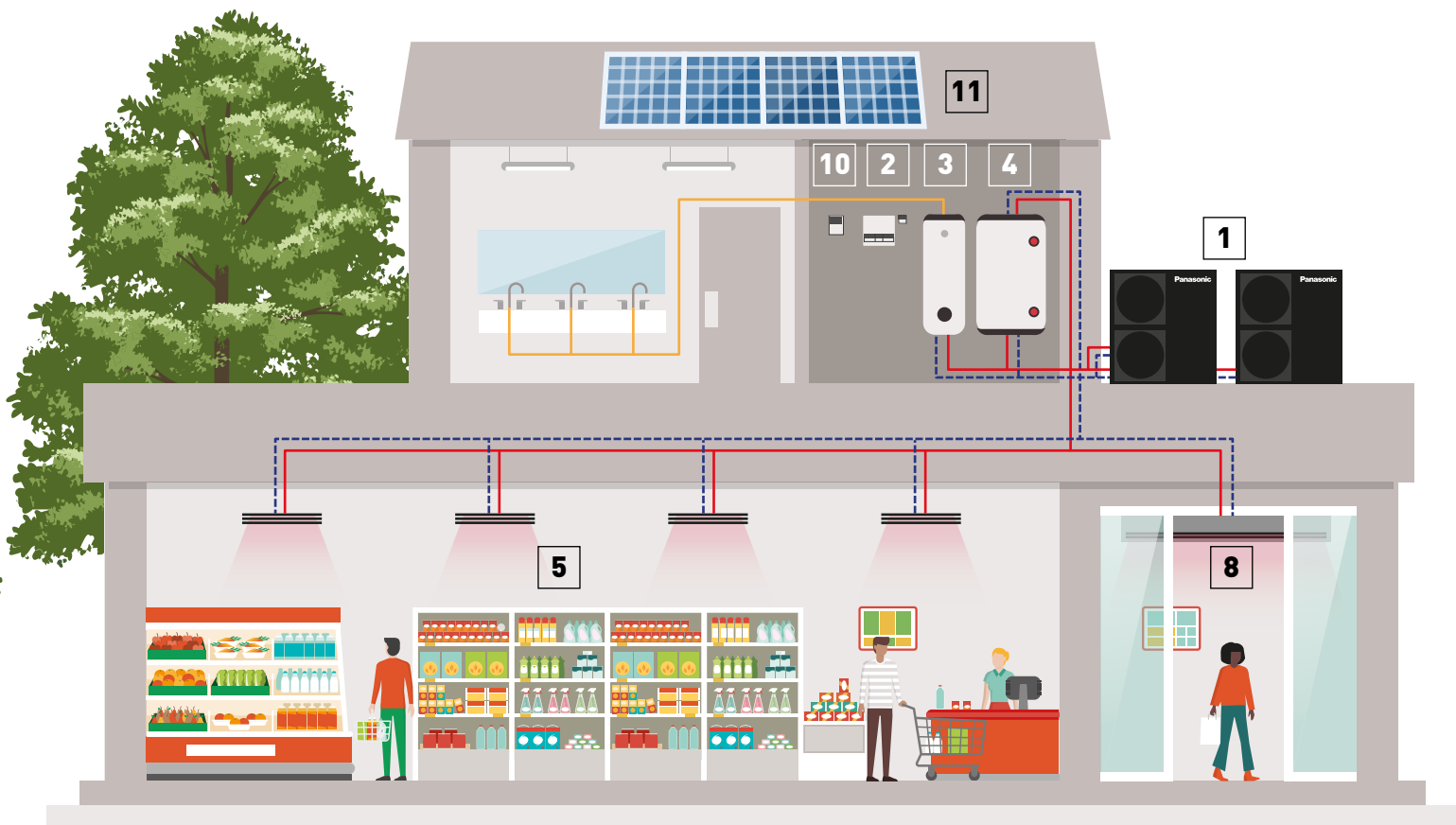

7
OPTIONAL.
Bivalent mode.
Cost-effective bivalent mode with energy tariff logic when combined with an existing boiler.



8
Air Curtain with water Coil.
Water coil air curtains can be used in the hydraulic system to have efficient performance of the water system.

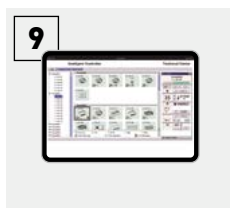

9
BMS integration.
The system can be easily integrated into a Modbus project with the optional accessory.



10
Cascade manager.
Manages up to 10 Aquarea Heat Pumps, balancing working hours, can control up to 2 buffer tanks and integrates PV, among others.



11
Photovoltaics.
Thanks to the integration with PV, the demand or power consumption for heating or hot water production is adapted to the PV production.



Burger & Lobster restaurant. Bath, UK.
Panasonic's air to water Aquarea system has been installed in the latest glamorous Burger & Lobster restaurant in Bath. The Octagon Chapel, a large listed building in the city centre, was converted to accommodate the restaurant, and Panasonic's Aquarea system provided an extensive, energy efficient and unobtrusive heating and cooling solution.

Aquarea All in One Hydraulic M Series

The ultimate space-saving solution.



Premium white indoor units.

The indoor unit is designed to blend into your interior space effortlessly. In premium white, faithful to the Aquarea spirit, underlined by the seamlessly integrated controller which provides a sleek black band across the unit.



599 x 602 mm footprint
reduces required
installation space.



No buffer tank required,
reducing space, cost and
installation time.



Up to 40% more tap water
with a higher tank
temperature setting.

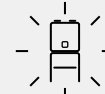

**Robust body and top
surface enables
installation of a top
ventilation unit.**

Aquarea All-in-One M series: the best Panasonic technology.



* Tentative information.

Great serviceability.

- Easy access to hydraulic part thanks to door opening mechanism
- All sensors can be checked from the remote controller
- Water pressure sensor and reading on home-screen

Other high quality components inside.

- Maintenance free Inox stainless 185 l tank
- Variable speed water pump ("A class")
- Backup heater
- 3 way valve inside



Extended elevation difference (up to 30 m).

With the new expansion vessel, the All in One M Series allows a high indoor/outdoor height difference of up to 30 m.

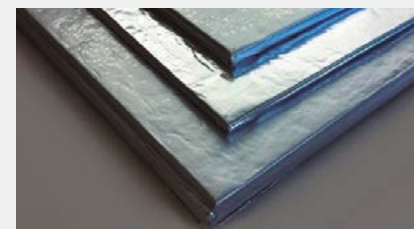

U-Vacua™ Vacuum insulation panel.

U-Vacua™ panels offer 19 times the insulation performance of polystyrene foam. Since the system retains heat longer, it needs to heat up fewer times each day, resulting in energy savings.

Aquarea All in One with 2 zone control.

The optimal solution for installations with 2 heating zones.

- 2 heating circuits, with 2 different water temperatures
- 2 variable speed water pumps "A class" and 2 water filters
- Floor heating water control with mixing valve

Aquarea All in One with Electrical Anode:

The All in One with built-in impressed current anode is the ideal solution for installations in locations with harsh water conditions.

Aquarea K Series

A revolution in design, efficiency, connectivity and sustainability. Aquarea K Series is a ground breaking low-energy system for heating, cooling and domestic hot water production that delivers outstanding performance. This model is ideal for new installations and well-insulated homes.

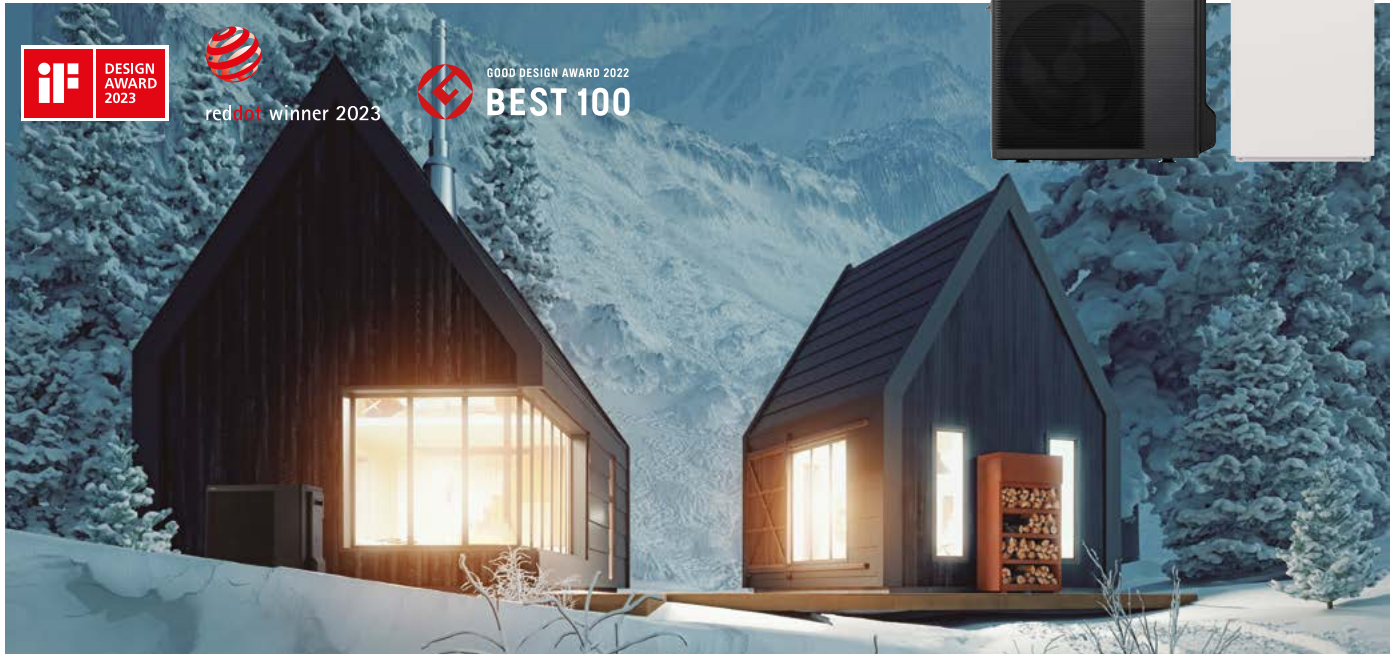

Wide range. Wide range to suit all homes: High Performance and T-CAP.	Further noise reduction. -8 dB(A) in Quiet mode.	Optional remote control and maintenance. Aquarea Smart Cloud. Aquarea Service Cloud.	High energy efficiency for heating. High energy class for low temperature applications*.	High energy efficiency for domestic hot water. DHW COP up to 3,5*. <small>* Scale from A+ to F.</small>	Output water. Up to 60 °C water outlet down to -10 °C outdoor.

Further advanced features

- High tank insulation performance thanks to U-Vacua™*.
- Less frequent maintenance with pre-installed magnet filter
- Water pressure sensor built-in
- Easy access to hydraulic parts

- Operation without backup heater at -25 °C
- Bluefin treatment protection on outdoor heat exchanger for harsh ambient conditions

* Only applicable to All in One indoor unit. U-Vacua™ is a vacuum insulation panel (VIP) technology.

Aquarea K Series keeps 60 °C water outlet temperature even at very low temperatures

Aquarea K Series is able to keep 60 °C water outlet temperature in outdoor temperatures down to -10 °C, keeping high comfort in the room even at low temperatures. With other heat pumps, water temperature dramatically drops at low outdoor temperatures, making the heat pump to work out of the design conditions and creating discomfort inside the room.

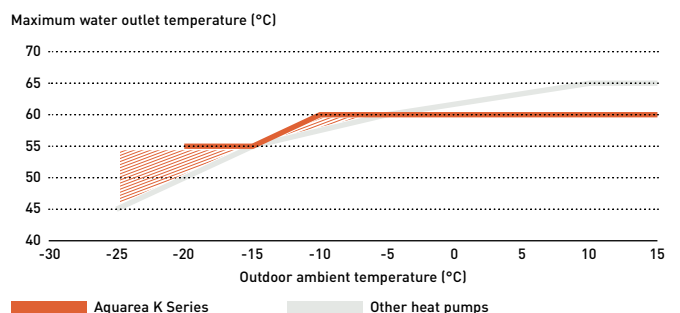

Aquarea K Series for every project need.

Available in both T-CAP and High Performance, the Aquarea K Series offers a versatile range of solutions to suit different project sizes and needs.



The outdoor unit is designed to harmonize with architecture and the environment

The compressor, which is a major source of noise, is equipped with a double-bottomed structure to provide a safe, quiet structure that does not disturb neighbours in crowded residential areas.



-8 dB(A) in Quiet mode

Aquarea High Performance K Series.

For new installations and low consumption homes. Suitable for a wide range of properties that demand exceptional efficiency and high energy savings. Featuring COPs as high as 5,33¹⁾ this solution is perfect for either underfloor heating or low temperature radiators.

¹⁾ K and J Series 3 kW.

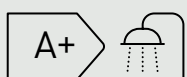

Energy efficiency class up to A+.

Scale from A+ to F.

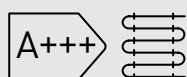

ErP 35 °C. Energy efficiency class up to A+++.

Scale from A+++ to D.

* Rating conditions: Heating: Inside air temperature: 20 °C Dry Bulb / Outside air temperature: 7 °C Dry Bulb / 6 °C Wet Bulb. Conditions: Water input temperature: 30 °C / Water output temperature: 35 °C. These energy efficiency might not apply to all models.

With a COP of 5,33, the Aquarea Heat Pumps offers savings of up to 82% on heating costs compared to electric heaters, as a large portion of the energy is extracted from the air for free.

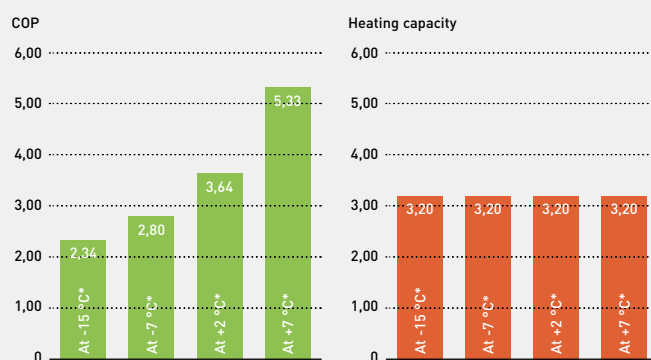

* KIT-ADC03K3E5 at 35 °C water outlet.

Aquarea T-CAP K Series.

For retrofit and new builds, the ideal solution for those installations where the output capacity is demanding.

The entire Aquarea T-CAP line-up is excellent for replacing gas or oil boilers and for connecting to new underfloor heating, radiators or fan coil units.

Aquarea T-CAP can maintain the rated heating capacity even at -20 °C¹⁾ outdoor temperature, without requiring an electrical heater. This makes it an ideal solution for locations with extremely low temperatures

¹⁾ At 35 °C flow temperature.

Aquarea T-CAP, high performance whatever the climate

With Aquarea T-CAP technology, Panasonic heat pumps can work in outdoor temperatures as low as -28 °C and maintain capacity without backup heating at -20 °C*.

¹⁾ 35 °C flow temperature.

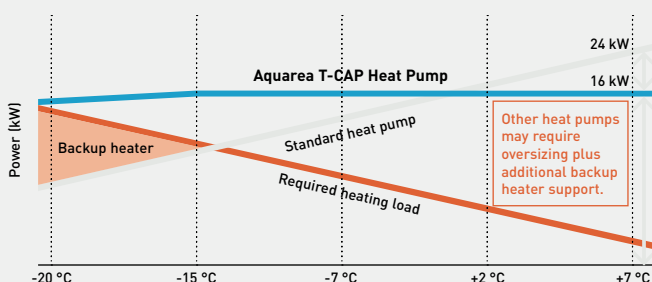

How Aquarea T-CAP K Series maintains performance even at -20 °C outdoors

A patent has been obtained for technology that can maintain heating capacity even in low outdoor temperatures through optimal control that comes from incorporating dual-piped heat exchanger into the refrigeration cycle.

Dual-piped heat exchanger.
Low pressure and low-temperature refrigerant in the inner pipe.

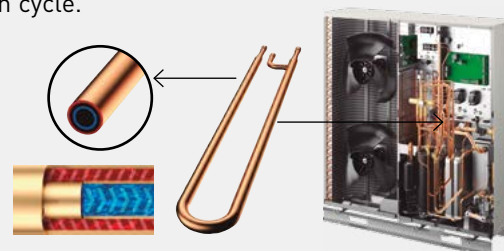

Aquarea EcoFlex

2-in-1 - Sustainable and efficient comfort all year long.

Aquarea EcoFlex is a groundbreaking heat pump that connects an air ducted unit with nanoe™ X technology providing heat recovery hot water, space heating, space cooling and cleaner air. Outstanding efficiency and energy savings with low CO₂ emissions.



Heating, cooling and domestic hot water systems for a green future.

With Aquarea Heat Pump the heat energy is taken from the ambient air. One outdoor unit for synchronous air to air and air to water supply.



Multi solution.

Trendy air to water + DX value added solution, featuring bi-heating (simultaneous air heating and DHW or heating), heat recovery function (re-use wasted heat from the outdoor unit for DHW production) and Non-stop heating (air heating runs continuously even in defrost operation).

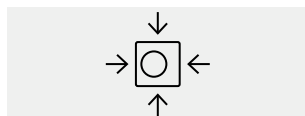

Compact design.

Ideal for installations with limited spaces. The compact outdoor unit can supply both air conditioning and hot water at the same time. The Tank fits beautifully in any kitchen, small laundry space, or any other desired area. No need for gas supply.



Smart convenience.

Energy savings, comfort and control from anywhere. Aquarea EcoFlex is equipped standard with Wi-Fi to enable smart control and energy consumption monitoring, using Aquarea Smart Cloud.



nanoe™ X technology to improve protection 24/7.

This advanced technology utilises hydroxyl radicals (also known as OH radicals), which inhibit the growth of certain pollutants such as allergens, bacteria, viruses, moulds, odours, and certain hazardous substances.



Unique technology that drives the system

Heat recovery.

Cooling (air to air) + DHW (air to water).

Heat exchange that took place in outdoor unit now is carried out in the water heater.

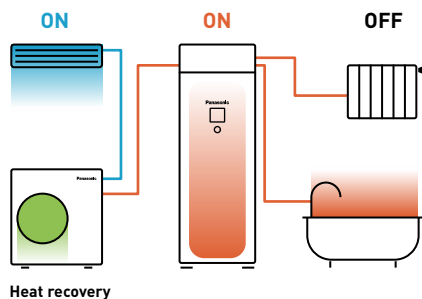

Bi-heating.

Heating (air to air) + Heating (air to water) or DHW.

Heat from the compressor is supplied for heating and DHW simultaneously.

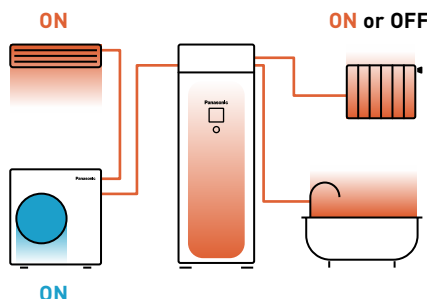

Non-stop heating.

Heating (air to air) continuous operation.

Use heat from tank to defrost and heat simultaneously.

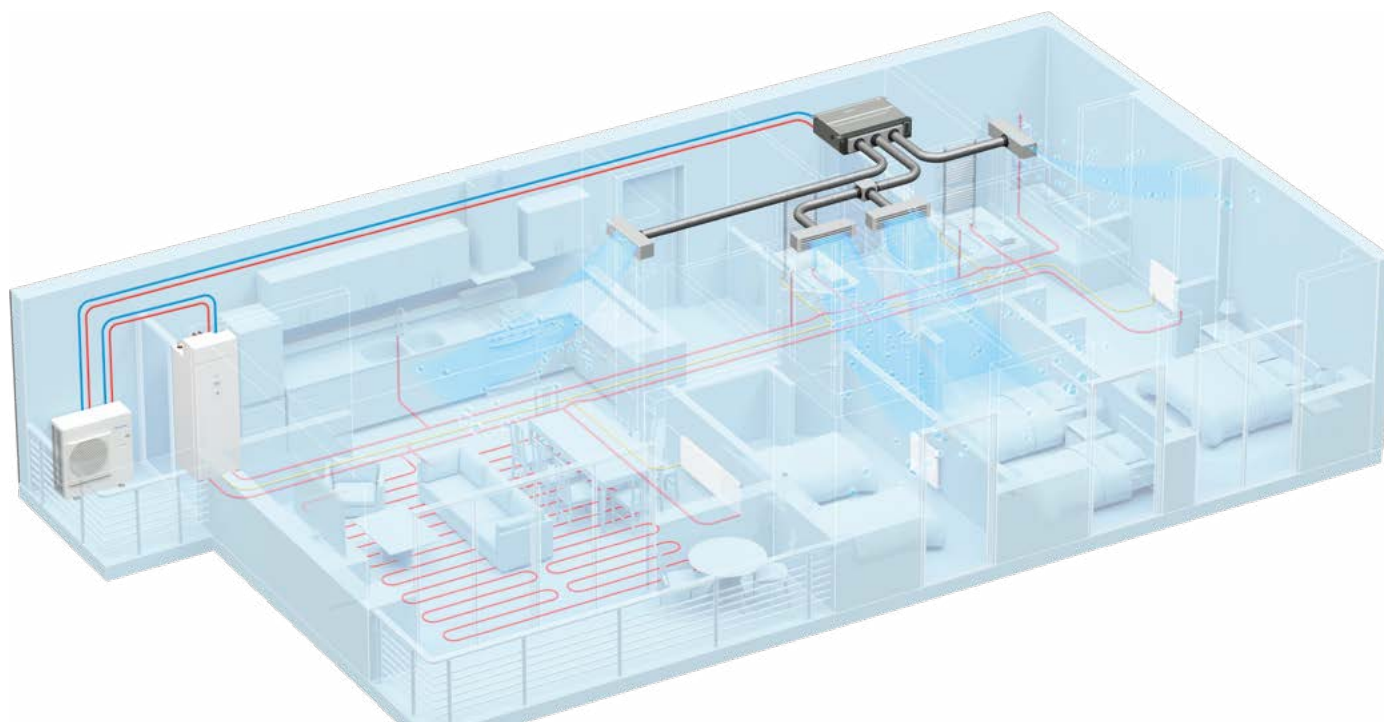
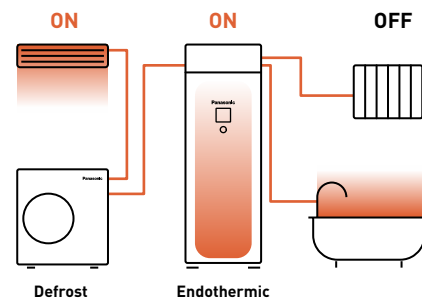

Aquarea EcoFlex.

Air to water

Tank unit + heat exchanger box to produce domestic hot water and space heating using radiators or floor heating.



Fits beautifully in any kitchen, small laundry space, or any other desired area

Kitchen.



Laundry space.



The same depth as a regular refrigerator/washing machine.

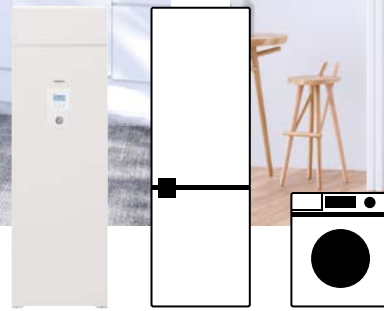

Deep: 600 mm
Wide: 598 mm

Deep: 600 mm
Wide: 600 mm

Deep: 600 mm
Wide: 600 mm

Compact, yet easy to maintain



1 | Heat exchanger box structure to mitigate R32 refrigerant restrictions, flexible installation.

Water heat exchanger is designed above the top plate to comply with installation area regulation for products using large amounts of R32 refrigerant.



2 | Maintained serviceability.

- Easy maintenance concept
- Access to hydraulic parts thanks to door opening mechanism
- No buffer tank required, reducing space, cost and installation time



Width: 116 mm
Height: 250 mm

3 | Improved water filter for less maintenance.

Superior dust removal capacity of the water filter. Less frequent filter cleaning means more convenience.



Deep: 600 mm
Wide: 598 mm

185 L

4 | Slim indoor unit with big tank capacity.

Built-in 185 L water tank in a slim W 598 x D 600 mm indoor unit housing.

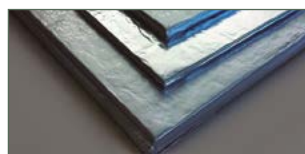

5 | U-Vacua insulation technology.

Panasonic U-Vacua™ is a high performance vacuum insulation panel with very low thermal conductivity, that performs about 19 times better than standard urethane foam.

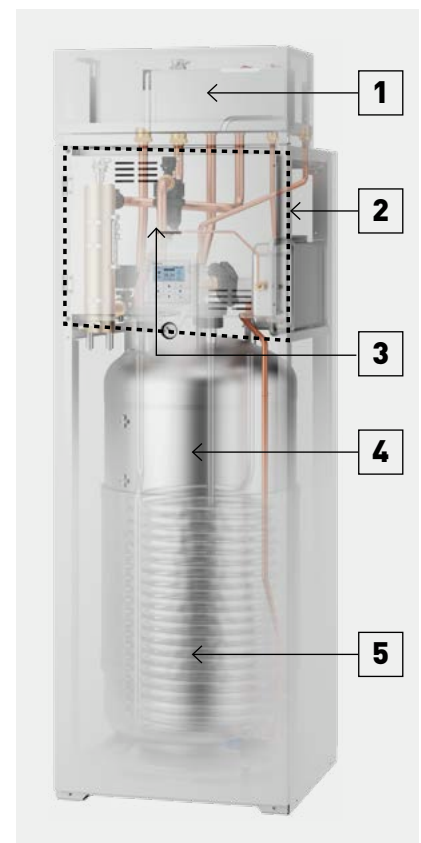

Aquarea EcoFleX. Air heating or cooling and cleaner air

Aquarea EcoFleX ducted unit has been designed to provide better comfort and flexibility.



Superior air quality

Standard equipped with nanoe™ X, a unique technology that cleans indoor air.



Ideal for living spaces

- Static pressure level: 10 - 150 Pa
- Compact body: Only 250 mm high
- Smart control ready via CONEX
- Rated up to SEER / SCOP class A+/A
- Low noise operation (34 dB(A)) using an improved fan casing
- DC fan motor, built-in drain pump



Panasonic's nanoe™ X technology takes this a step further and brings nature's detergent – hydroxyl radicals – indoors to help create an ideal environment

Thanks to the nanoe™ X properties, several types of pollutants™ can be inhibited such as certain types of bacteria, viruses, mould, allergens, pollen and certain hazardous substances.

Deodorises

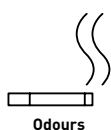

Odours

Capacity to inhibit 5 types of pollutants



Bacteria and viruses



Mould



Allergens



Pollen



Hazardous substances



Skin and hair

The nanoe™ X performance varies depending on the room size, environment and usage and it may take several hours to reach the full effect. nanoe™ X is not medical device, local regulations on building design and sanitary recommendations must be followed.

REFER TO PAGE 12 FOR MORE DETAILS AND VALIDATION DATA

nanoe™ X: improving protection 24/7

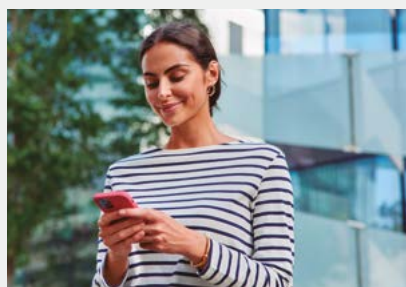

Acts to clean your air, so that the indoor environment can be a cleaner and more pleasant place to be all day long. nanoe™ X works together with heating or cooling function when you are at home and can work independently when you are away. Give the air conditioning the strength to increase the protection at home with nanoe™ X technology and convenient control via the Panasonic Comfort Cloud App.



Cleans the air when you are away.

Leave the nanoe™ mode ON to inhibit certain pollutants and deodorise before you return home.

Improves your environment when you are at home.

Enjoy a cleaner, comfortable space with loved ones.

Selectable inlet air position

Inlet air position may be adjusted by means of a removable panel, to allow rear or bottom entry, depending on the duct installation.

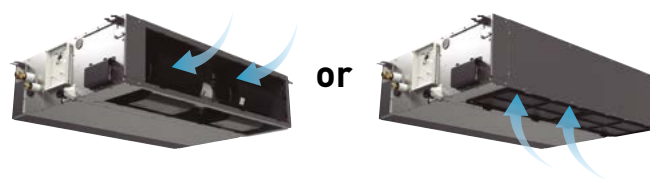

Compact body

- Only 250 mm high
- Light units from 25 to 39 kg

Conventional model	33 kg	290 mm
Ducted unit	30 kg	250 mm

Ducted unit



Aquarea Smart Cloud for the end user

The IoT solution to help maximise comfort while managing energy consumption. Energy savings, comfort and control from anywhere. Aquarea Smart Cloud provides a powerful and user-friendly service for the management and monitoring of Aquarea Heat Pumps for the end users and enables remote maintenance by service partners.



WATCH DEMO

* Requires Wi-Fi adapter CZ-TAW1B or CZ-TAW1C.



Remote control from anywhere, anytime

Aquarea Smart Cloud provides a powerful and user-friendly service for the management and monitoring of Aquarea's heating, cooling and hot water functions, including scheduling and malfunction notification.

Easy and powerful energy management

Monitor the energy consumption of the Aquarea Heat Pump at different time intervals by comparing the energy usage patterns to maximise energy savings. It is also possible to monitor the energy recovered to produce domestic hot water with the EcoFlex.

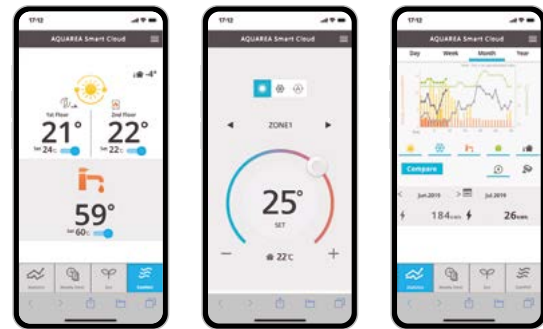

Requirements

- 1 | Aquarea H Series or later
- 2 | Cloud adapter CZ-TAW1B or CZ-TAW1C
Included in M and L Series, and EcoFlex. For other series, it needs to be purchased separately.
- 3 | In-house WLAN or Wi-Fi internet connection
- 4 | Smartphone, PC or tablet with internet connection

Access to Aquarea Smart Cloud

1. Panasonic Comfort Cloud App

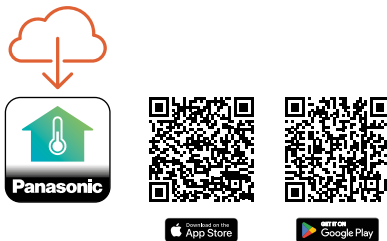

2. Via web browser

<https://aquarea-smart.panasonic.com/>



* User interface image may change without notification.

Aquarea compatibility	H Series onwards
Connection point	CN-CNT port
Router connection	WLAN or Wi-Fi
Control functions available (up to 2 heating zones)	ON / OFF - Temperature setting - Mode selection - DHW setting - Error codes - Scheduling
Monitoring functions	Energy consumption estimation - Operation log history

More possibilities with IFTTT

IF This Then That: IFTTT service enables user to automatically trigger actions for Aquarea system based on other apps, web services or devices.

Connect your Aquarea to your voice assistant, get an e-mail if your Aquarea gets an error or automatically turn on your Aquarea on Heat Mode when outdoor temperature drops below specified level.



Get the most out of your Aquarea Heat Pumps

Aquarea+ offers end user useful information to operate a Panasonic Aquarea Heat Pumps to provide heating, cooling and hot water in the most efficient and cost effective way.

AQUAREA+



Aquarea Service Cloud

With the Aquarea Service Cloud, installers can remotely take care of their customers' heating systems. It saves time and money and shortens the response time, thus increasing the customers' satisfaction.



WATCH DEMO

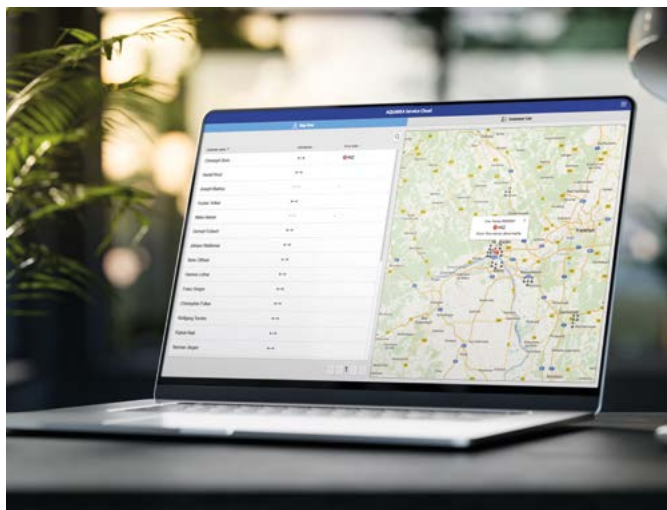

Time and cost saving.

Remote system adjustment.
Remote diagnosis. One visit, spare part in hand.



Increased customer satisfaction.

Faster service. Time saving (less number of visits).

The real remote maintenance made simple

- Global view at a glance
- Heat pump information and settings
- Error log history
- Statistics always available

Home page.

Status of connected users at a glance. 2 view options: map view or list view.

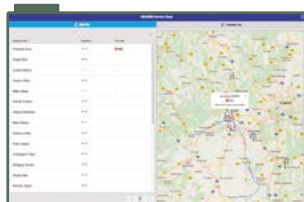

Status tab.

Current status of unit with a maximum 28 parameters.



Statistics tab.

Customisable statistics of a maximum of 71 parameters. Available anytime with the information of the last 7 days.



Settings tab.

Most of the user and installer settings can be done remotely.



Activation of the Aquarea Service Cloud. Requirements

1. End user: Aquarea Heat Pumps connected to Aquarea Smart Cloud

End user registration: <https://aquarea-smart.panasonic.com/>

2. Installer/maintenance company: Service ID

Installer registration: <https://aquarea-service.panasonic.com/>

Connecting the unit to the Aquarea Service Cloud.

The process can be initiated by the end user or by the installer.

The end user can select and change the installer's level of control anytime (4 levels).

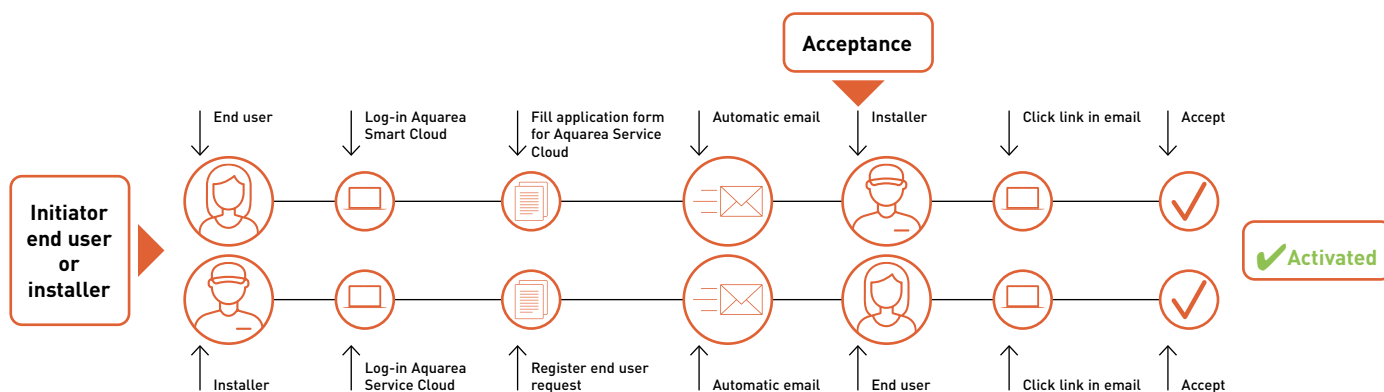

Control and connectivity

Home connectivity and Home Managements Systems integration is becoming more and more popular. These integrations helps to control all house devices from centralised platform and helps to optimise the operation and running costs. Panasonic interfaces are made to work with both KNX and Modbus, the most populars protocols. Also for non integrated control, Panasonic developed a simple connection to Wireless LAN, with this end user can control remotely its own heat pump from wherever.



Control by BMS

Modbus: PAW-AW-MBS-H (Intesis) and PAW-AZAW-MBS-1 (Airzone).
KNX: PAW-AW-KNX-H (Intesis) and PAW-AZAW-KNX-1 (Airzone).

Great flexibility for integration into your KNX / Modbus projects allows fully bi-directional monitoring and control of all the functioning parameters.

- Quick installation
- External power not required
- Direct connection to the unit via CN-CNT connector
- Bidirectional control
- Unit can be controller simultaneously by remote controller and the gateway
- Compatible with H Series onwards

* For specific functionality list of each gateway, please check the user's manual.



External meter gateway

PAW-A2W-EXTMETER

- Energy consumption and production from external Modbus RTU meters
- Real values visualized via Aquarea remote controller and Aquarea Smart Cloud
- Compatible with Aquarea K Series onwards



Possibility to mix internal calculation and external meters

Configuration	Electricity meter (HP)	Heat meter (heating and cooling)	Heat meter (DHW)
Only external meters	External	External	External
Only external consumption meter	External	Internal calculation	Internal calculation
Only external production meters (2 meters)	Internal calculation	External	External
Only external production meter (single meter for total production)	Internal calculation	External	Internal calculation

Functions:

- Configuration via App (iOS and Android) using Bluetooth®
- Easy to setup thanks to templates for some meters manufacturers
- Configuration can be done before and just send it on commissioning

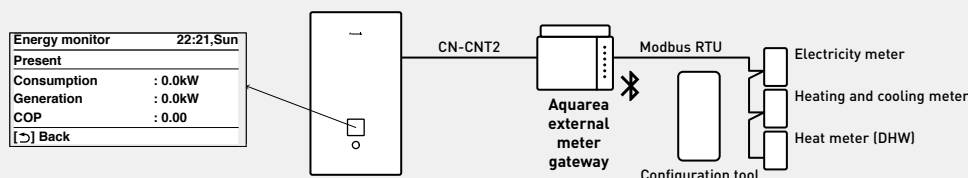

Advanced remote controller

Aquarea remote controller is designed in harmony with the whole system, with optimised user interface and improved features.

The remote controller can be removed from the indoor unit and installed in the living room.

K, L and M Series remote controller.

Dual controller system: A dual controller system for independent control of two zones within the home (requires additional remote controller CZ-RTW2 for M Series or CZ-RTW1 for K and L Series).

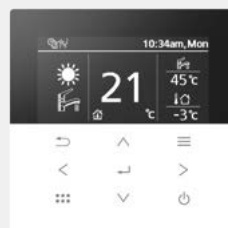
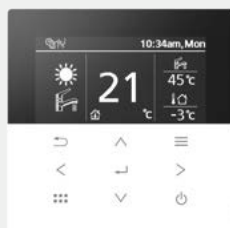

	K, L and M Series				H and J Series	
	Main controller		Sub controller		Main controller	
Quick menu	✓		✓		✓	
User menu	✓		✓		✓	
Installer / custom menu	✓		—		✓	
Maintenance menu	✓		—		✓	
Error reset	✓		✓		✓	
Internal thermostat	Zone 1	Zone 2	Zone 1	Zone 2	Zone 1	Zone 2
	✓	✓	✓	✓	✓	✓

Installer functions:

System setup, operation setup (including heating / cooling modes, ΔT setup), dry concrete mode and cost-effective bivalent mode*, among others.

* Only for K, L and M Series.

End user functions:

Mode selection (including auto, powerful and quiet modes), weekly timer and energy monitoring, among others.

PCBs for additional functions



CZ-NS4P: J and H Series.

CZ-NS5P: K and L Series.

CZ-NS6P: M Series All in One and Bi-bloc.

CZ-NS7P: M Series control module.

The optional PCB enables additional control functions for Aquarea Heat Pumps.

Functions available through the connection of the Optional PCB to the Main PCB:

- 2-zone control, with 2 mixing valves, 2 pumps and 2 room thermostats or sensors
- Control of swimming pool
- Solar thermal control
- External error signal output
- 0-10 V signal for heat pump demand control
- SG ready¹⁾
- Stop compressor by external compressor switch
- Switch heating and cooling by external heat-cool switch

¹⁾ Aquarea H and J Series heat pumps in combination with the optional PCB CZ-NSP4 hold the SG Ready Label (Smart Grid Ready Label), given by Bundesverband Wärmepumpe (German Heat Pump Association). This Label shows the real capacity of Aquarea to be connected in an intelligent grid control.

Cascade manager



PAW-A2W-CMH-2

- Cascade up to 10 heat pumps, getting up to 300 kW
- Manages the heat demand based on a PID logic, balancing working hours
- Integration of photovoltaics (PV optimised algorithm)
- Can control 3 way valves for cooling (2 buffer tanks)
- Heating / cooling 0-10 V demand signal – controls target outlet temperature
- DHW control
- Energy meters compatibility
 - Meters communication with Modbus RTU
 - Pre-configuration of 4 market popular meters
- BMS integration. LAN-Port settings with fixed IP and DHCP
- Optimised De-icing function
- Large, easy-to-use touch screen display, providing intuitive control
- All components in one case
- Compatible with Aquarea Heat Pumps H Series onwards*

* Requires 1 PAW-AW-MBS-H per each Aquarea.

How Panasonic contributes to Nearly Zero Energy Buildings (nZEB)

Our expertise gained over the years has helped to launch a range of products that contribute to a more carbon-free society.

Panasonic is committed to develop products with greater energy efficiency.

Highly efficient Panasonic solutions can help to significantly reduce the energy consumption of the house, at the same time a high level of comfort and good indoor air quality are kept.

- Aquarea High performance heat pump for heating, cooling and domestic hot water production
- Aquarea Smart Cloud, for energy monitoring
- Heat recovery ventilation system
- PV panels to produce renewable energy on-site



Aquarea Heat Pumps and the ventilation unit with heat recovery certified as Passive House Component

Aquarea High Performance All in One Compact and Bi-bloc J Series heat pumps¹⁾ and the ventilation unit with heat recovery PAW-A2W-VENTA have been certified by the Passive House Institute (PHI) as Passive House Component. This certification ensures highly energy efficient components according to international criteria for respective thermal performance, comfort and indoor air quality.

¹⁾ 3, 5 and 7 kW models.

Certified models can be checked under the certification section of <https://database.passivehouse.com>.



H3 Grande Passive House, Poland.

When looking for a energy-efficient heating solution, Polish construction company Procyon selected a 5 kW Panasonic Aquarea High Performance heat pump for its passive house project, H3 Grande. Procyon found this solution reduced annual heating expenses by almost half compared to an oil-based system, or by 10% in comparison to natural gas.

H3 Grande is a 175 m² detached house certified by the Passive House Institute (PHI) in Darmstadt. It is designed to minimise energy losses while incorporating an attractive, yet simple aesthetic. The building's shape, interior design and pitched roof contribute to the energy balance of the house, while large south-facing windows and wall insulation provide passive thermal comfort by retaining heat. The building has very low heating demand of approximately 15 W/m² and is designed to minimise energy.

Aquarea and PV integration

Aquarea Heat Pumps are designed with the future in mind. Thanks to the integration of the Aquarea Heat Pumps with PV, the demand or power consumption for heating, cooling and domestic hot water production is adapted to the PV production.

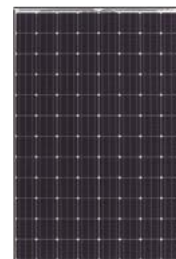

Savings on heat pump running costs.



Reduced primary energy consumption.



Lower CO₂ emissions.



Maximised comfort.

Aquarea Heat Pumps can be integrated with PV thanks to the optional PCB ¹⁾

With the SG ready function, the Aquarea Heat Pumps will be able to store thermal energy during periods where the electricity produced is higher than the demand in the house. These are some examples:

1. Store DHW at higher temperature. Aquarea M and L Series can produce DHW at 65 °C up to 40% more tap water
2. Heat or cool the house to maintain a comfortable temperature continuously. This requires less energy during the off-peak production hours
3. Store thermal energy in a buffer tank

1) CZ-NS*P. Check the model reference by Series in the control and connectivity section.

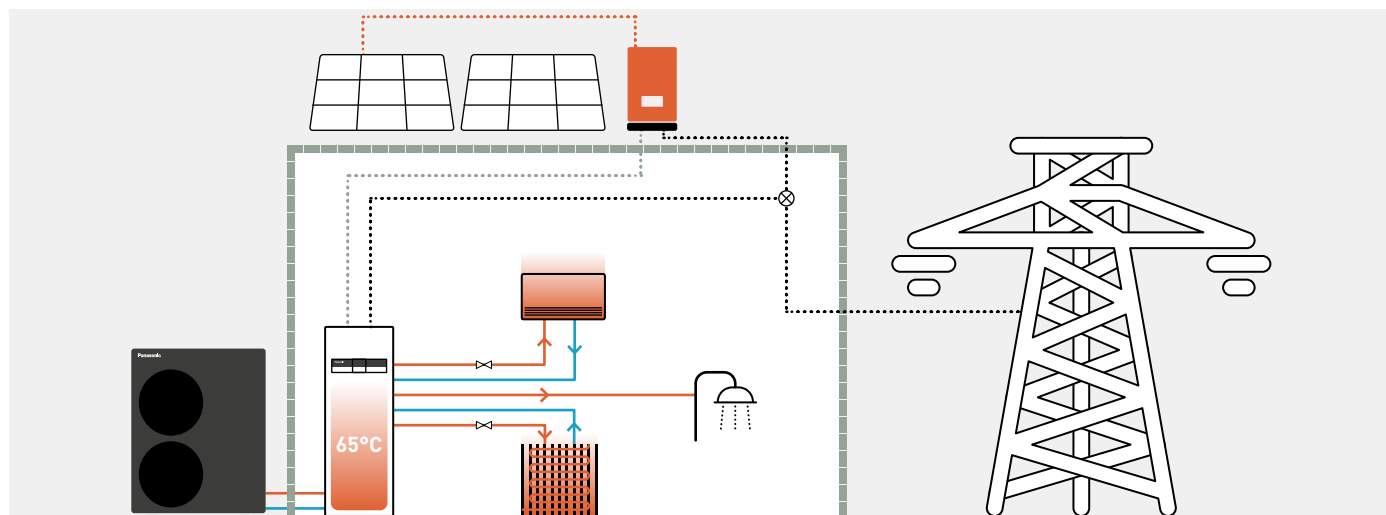

Turning a family home into an energy-neutral house.

Installer Sinne Technyk chose the Aquarea T-CAP heat pump in combination with HIT KURO photovoltaic panels for a house in Oudemirdum in Friesland, the Netherlands. With this combination, the household enjoys energy-neutral and free heating and hot water, as well as a more comfortable indoor climate. "The aim was to create an energy-neutral house and to reduce gas consumption to zero," explains Leo van der Molen of Sinne Technyk. "This makes a heat pump an interesting option". With the comfort of customers and neighbours in mind, a silent Aquarea T-CAP heat pump was chosen, powered by 24 Panasonic HIT KURO solar panels of 325 Wp each.

Panasonic PRO Club makes your life easier. All Aquarea Designer - online tool can be found there

Panasonic has an impressive range of support services for designers, specifiers, engineers and distributors working in air to water heat pump projects.



Energy Label

Fridges, dishwashers, washing machines, ovens – it all started with white goods in the 1990s. Today, other energy-consuming appliances also carry the European energy efficiency label, such as televisions and lighting. From 2013, the regulations applied to air conditioners and heat pumps but since September 2015, it has also been applicable to room heaters, water heaters and storage water heaters.

Minimum energy efficiency requirements are also specified for manufacturers of system and combi boilers, water heaters and DHW cylinders.

The purpose of Energy Labels are to assist consumers in their purchasing decisions, as well as ecodesign requirements on products which help reduce private energy demand and help to reduce global warming.

Panasonic helps you to calculate the system label.

From 26th September 2015, installers can be assured that all products manufactured after this date will be sold with the required energy efficiency labels which will aid installers with their paperwork. While it is the manufacturer's responsibility to issue their products with the required labels, the installers will need to calculate and issue an energy efficiency label for the entire heating system. Whether installing a new heating system or installing new boilers, controls or renewables into an existing system, it is, and will continue to be, the installer's responsibility to calculate and issue energy efficiency labels. Calculators which assist installers with this process are available on www.panasonicproclub.com.

Information on the energy efficiency label.

The rating system for heat pumps classifies them into seven efficiency categories. From 26th September 2019, the best energy efficiency category is A+++, least energy efficient is D. The energy efficiency label for system boilers shows its efficiency category on a scale from A+++ to D, and from A+ to F for hot water cylinders.

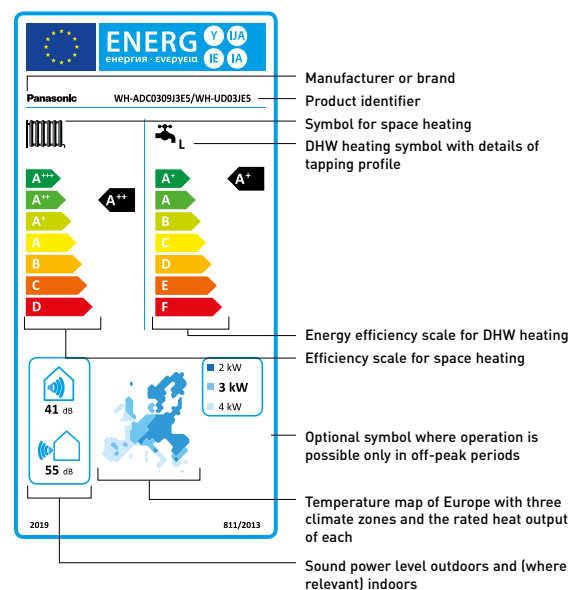

Panasonic helps you to calculate the system label www.panasonicproclub.com or connect simply with your smartphone to the PRO Club using this QR.

PRO Club 



Aquarea Designer - online tool

With Panasonic's online tool, projects can be developed simply and easily. The newly developed tool is optimised to help HVAC professionals easily identify the most appropriate Aquarea air to water heat pump for a particular application.



Aquarea Designer

This program allows HVAC designers, installers and distributors to identify the correct heat pump for a particular application from Panasonic's Aquarea range, calculate the savings compared to other heat sources and very quickly calculate CO₂ emissions.

Using Panasonic's Aquarea Designer, projects can be developed simply and easily, by either using the Quick Design or Expert Design options. Each allows the user to build up the project data in a simple step-by-step process and choose to output reports (project data input includes: either Quick or Large formats) as HTML files or as print-outs. To create these useful reports, project data is input, including:

- Heated area
- Heating requirement
- Heating flow and return temperatures
- Climate data (from a simple drop-down menu) including outdoor temperature
- Type of hot water tank, storage capacity and hot water target temperature



Hydraulic scheme generator

The new Aquarea Hydraulic Scheme Generator (HSG) allows users to select a hydraulic schematic according to their installation requirements. This will be accompanied by the relevant electrical connection schematic and component list.

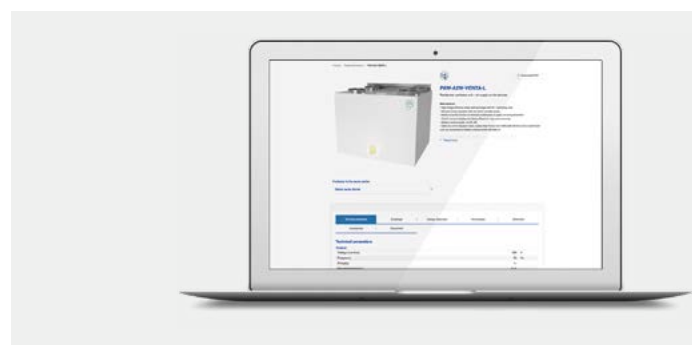
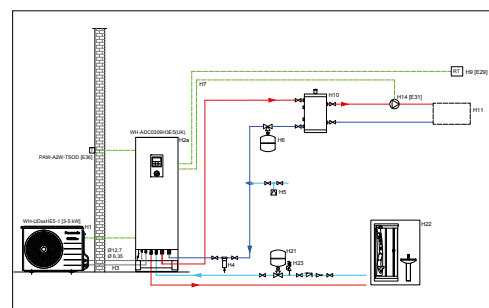

Residential ventilation selection tool.

The tool contains all the information the HVAC professionals need for their residential ventilation projects (specifications, technical manuals, etc.) as well as a calculator of the performance curves.

Heating demand calculator

This software can quickly and easily determine the heating requirements for the rooms in a project. The Heating demand calculator will help determine approximately how much power is needed to heat each room individually. The result in kilowatts will help you choose the space heater best suited to your needs.

CAD images and spec texts

In order to add value in the design of projects, Panasonic has a wide library of 2D CAD, BIM objects (Building Information Modeling) and Spec texts to be used in Revit.

All the support tools are available in Panasonic PRO Club (www.panasonicproclub.com).

Among many others, these are the main tools for the design of Aquarea projects.











Try the new Panasonic Augmented Reality projector.



Helping you to find the Aquarea Heat Pumps for your home in just a few clicks!

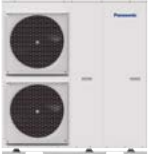

Aquarea Hydraulic

Aquarea High Performance		5 kW	7 kW	9 kW	12 kW	16 kW			
P. 54	All in One 1ph			WH-ADC0509L3E5 ¹⁾ WH-ADC0509L3E5B WH-ADC0509L3E5AN ¹⁾ WH-WDG05LE5	WH-ADC0509L3E5 ¹⁾ WH-ADC0509L3E5B WH-ADC0509L3E5AN ¹⁾ WH-WDG07LE5	WH-ADC0509L3E5 ¹⁾ WH-ADC0509L3E5B WH-ADC0509L3E5AN ¹⁾ WH-WDG09LE5			
				P. 54	Bi-bloc 1ph			WH-SDC0509L3E5 ¹⁾ WH-WDG05LE5	WH-SDC0509L3E5 ¹⁾ WH-WDG07LE5
P. 56, 57	Mono-bloc 1ph		WH-MDC05J3E5	WH-MDC07J3E5	WH-MDC09J3E5	WH-MDC12H6E5	WH-MDC16H6E5		
Aquarea T-CAP		9 kW	12 kW	16 kW	20 kW	25 kW	30 kW		
P. 58	All in One 1ph ²⁾ - 3ph			NEW WH-ADC0316M3E52 ¹⁾²⁾ WH-ADC0316M3E5AN2 ¹⁾²⁾ WH-ADC0316M9E82 WH-ADC0316M9E8AN2 WH-WXG09ME5 WH-WXG09ME8	NEW WH-ADC0316M3E52 ¹⁾²⁾ WH-ADC0316M3E5AN2 ¹⁾²⁾ WH-ADC0316M9E82 WH-ADC0316M9E8AN2 WH-WXG12ME5 WH-WXG12ME8	NEW WH-ADC0316M9E82 WH-ADC0316M9E8AN2 WH-WXG16ME8			
				P. 58	Control module ²⁾ 1ph - 3ph			NEW WH-CME5 WH-CME8 WH-WXG09ME5 WH-WXG09ME8	NEW WH-CME5 WH-CME8 WH-WXG12ME5 WH-WXG12ME8
P. 58	Stand-alone ³⁾ 1ph - 3ph			NEW WH-WXG09ME5 ²⁾ WH-WXG09ME8	NEW WH-WXG12ME5 ²⁾ WH-WXG12ME8	NEW WH-WXG16ME8	NEW WH-WXG20ME8 ²⁾	NEW WH-WXG25ME8 ²⁾	NEW WH-WXG30ME8 ²⁾
P. 60	Mono-bloc 1ph - 3ph		WH-MXC09J3E5 WH-MXC09J3E8	WH-MXC12J6E5 WH-MXC12J9E8	WH-MXC16J9E8				

Models with R290 refrigerant. Models with R32 refrigerant. Models with R410A refrigerant.

1) Also available with other backup heater capacities. 2) Available in Summer 2024. 3) Requires CZ-RTW2TAW1C remote controller with Wi-Fi adapter.
WH-__E5 1ph // WH-__E8 3ph.

Aquarea Split



Check all our certified heat pumps on:
www.heatpumpkeymark.com

Aquarea EcoFlex

8 kW

P. 61 1ph



WH-ADF0309J3E5CM
S-71WF3E
CU-2WZ71YBE5

Aquarea High Performance

3 kW

5 kW

7 kW

9 kW

12 kW

16 kW

P. 63, 64, 65, 66, 67, 68, 69
All in One
1ph - 3ph



WH-ADC0309K3E5 ¹⁾
WH-ADC0309K3E5B
WH-ADC0309K3E5AN ¹⁾
WH-UDZ03KE5

WH-ADC0309K3E5 ¹⁾
WH-ADC0309K3E5B
WH-ADC0309K3E5AN ¹⁾
WH-UDZ05KE5

WH-ADC0309K3E5 ¹⁾
WH-ADC0309K3E5B
WH-ADC0309K3E5AN ¹⁾
WH-UDZ07KE5

NEW
WH-ADC0912K9E8 ²⁾
WH-ADC0912K9E8AN ²⁾
WH-UDZ09KE8 ²⁾

WH-ADC0916H9E8
WH-UD09HE8

WH-ADC0912K6E5 ²⁾
WH-ADC0912K6E5AN ²⁾
WH-UDZ12KE5 ²⁾
WH-ADC1216H6E5C
WH-UD12HE5

NEW
WH-ADC0912K9E8 ²⁾
WH-ADC0912K9E8AN ²⁾
WH-UDZ12KE8 ²⁾

WH-ADC0916H9E8
WH-UD12HE8

WH-ADC1216H6E5C
WH-UD16HE5

NEW
WH-ADC16K9E8 ²⁾
WH-ADC16K9E8AN ²⁾
WH-UDZ16KE8 ²⁾

WH-ADC0916H9E8
WH-UD16HE8

P. 70, 71, 72
Bi-bloc
1ph - 3ph



WH-SDC0309K3E5 ¹⁾
WH-UDZ03KE5

WH-SDC0309K3E5 ¹⁾
WH-UDZ05KE5

WH-SDC0309K3E5 ¹⁾
WH-UDZ07KE5

WH-SDC0309K3E5 ¹⁾
WH-UDZ09KE5

NEW
WH-SDC09K3E8 ^{1) 2)}
WH-UDZ09KE8 ²⁾

WH-SDC09H3E8
WH-UD09HE8

WH-SDC12K6E5 ²⁾
WH-UDZ12KE5 ²⁾
WH-SDC12H6E5
WH-UD12HE5

NEW
WH-SDC12K9E8 ²⁾
WH-UDZ12KE8 ²⁾

WH-SDC12H9E8
WH-UD12HE8

WH-SDC16H6E5
WH-UD16HE5

NEW
WH-SDC16K9E8 ²⁾
WH-UDZ16KE8 ²⁾

WH-SDC16H9E8
WH-UD16HE8

Aquarea T-CAP

9 kW

12 kW

16 kW

P. 73, 74, 75, 76
All in One
1ph - 3ph



WH-ADC0912K6E5
WH-ADC0912K6E5AN
WH-UXZ09KE5

WH-ADC0912K9E8 ²⁾
WH-UXZ09KE8 ²⁾
WH-ADC0916H9E8
WH-UX09HE8
WH-UQ09HE8

WH-ADC0912K6E5
WH-ADC0912K6E5AN
WH-UXZ12KE5

WH-ADC0912K9E8 ²⁾
WH-UXZ12KE8 ²⁾
WH-ADC0916H9E8
WH-UX12HE8
WH-UQ12HE8

WH-ADC16K9E8 ²⁾
WH-UXZ16KE8 ²⁾
WH-ADC0916H9E8
WH-UX16HE8
WH-UQ16HE8

P. 77, 78, 79
Bi-bloc
1ph - 3ph



WH-SXC09K3E5 ^{1) 2)}
WH-UXZ09KE5 ²⁾
WH-SXC09H3E5
WH-UX09HE5

WH-SXC09K3E8 ²⁾
WH-UXZ09KE8 ²⁾
WH-SXC09H3E8
WH-UX09HE8
WH-SQC09H3E8
WH-UQ09HE8

WH-SXC12K6E5 ²⁾
WH-UXZ12KE5 ²⁾
WH-SXC12H6E5
WH-UX12HE5

WH-SXC12K9E8 ²⁾
WH-UXZ12KE8 ²⁾
WH-SXC12H9E8
WH-UX12HE8
WH-SQC12H9E8
WH-UQ12HE8

WH-SXC16K9E8 ²⁾
WH-UXZ16KE8 ²⁾
WH-SXC16H9E8
WH-UX16HE8
WH-SQC16H9E8
WH-UQ16HE8

Models with R32 refrigerant. Models with R410A refrigerant.

1) Also available with other backup heater capacities. 2) Available in Summer 2024.
WH-__E5 1ph // WH-__E8 3ph.

Aquarea High Performance Hydraulic L Series Single phase. Heating and Cooling · R290

Natural refrigerant R290 with GWP 3.

Energy efficiency: A+++ in heating at 35 °C.

Flexibility: Hydraulic connection between indoor and outdoor / Built-in magnetic water filter.

Comfort: Operation without backup heating at -25 °C / 75 °C water outlet temperature maximum at -10 °C outside temperature / 55 °C hot water even at -25 °C outside temperature.



* For All in One.

Indoor unit						Outdoor unit			
Backup heater capacity	DHW tank capacity	Electrical Anode	2 zones	Heating capacity					
				Single phase (power to indoor)					
				5,0 kW	7,0 kW	9,0 kW			
				WH-WDG05LE5	WH-WDG07LE5	WH-WDG09LE5			
Hydraulic All in One	1ph	3 kW	185 L	—	—	WH-ADC0509L3E5	✓	✓	✓
		3 kW	185 L	✓	—	WH-ADC0509L3E5AN	✓	✓	✓
		3 kW	185 L	—	✓	WH-ADC0509L3E5B	✓	✓	✓
		6 kW	185 L	—	—	WH-ADC0509L6E5	✓	✓	✓
		6 kW	185 L	✓	—	WH-ADC0509L6E5AN	✓	✓	✓
Hydraulic Bi-bloc	1ph	3 kW	—	—	—	WH-SDC0509L3E5	✓	✓	✓
		6 kW	—	—	—	WH-SDC0509L6E5	✓	✓	✓

Outdoor unit		WH-WDG05LE5	WH-WDG07LE5	WH-WDG09LE5	
Heating capacity / COP (A +7 °C, W 35 °C)	kW / COP	5,00/5,05	7,00/4,93	9,00/4,55	
Heating capacity / COP (A +7 °C, W 55 °C)	kW / COP	5,00/3,07	7,00/2,98	8,90/3,03	
Heating capacity / COP (A +2 °C, W 35 °C)	kW / COP	5,00/3,52	6,85/3,43	7,00/3,41	
Heating capacity / COP (A +2 °C, W 55 °C)	kW / COP	5,00/2,34	6,25/2,34	7,00/2,41	
Heating capacity / COP (A -7 °C, W 35 °C)	kW / COP	5,00/3,01	5,80/3,01	7,00/2,80	
Heating capacity / COP (A -7 °C, W 55 °C)	kW / COP	5,00/2,12	5,80/2,12	7,00/2,13	
Cooling capacity / EER (A 35 °C, W 7 °C)	kW / EER	5,00/3,23	7,00/3,03	8,20/2,82	
Cooling capacity / EER (A 35 °C, W 18 °C)	kW / EER	5,00/5,00	7,00/4,73	9,00/4,19	
Heating average climate (W 35 °C / W 55 °C)	Seasonal energy efficiency	SCOP (η _s %)	5,06/3,63(200/142)	4,96/3,62(195/142)	4,84/3,67(190/144)
	Energy class ¹⁾	A+++ to D	A+++/A++	A+++/A++	A+++/A++
Heating warm climate (W 35 °C / W 55 °C)	Seasonal energy efficiency	SCOP (η _s %)	6,00/4,27(237/168)	6,31/4,52(249/178)	6,44/4,50(255/177)
	Energy class ¹⁾	A+++ to D	A+++/A+++	A+++/A+++	A+++/A+++
Heating cold climate (W 35 °C / W 55 °C)	Seasonal energy efficiency	SCOP (η _s %)	4,25/3,28(167/128)	4,25/3,29(167/129)	4,31/3,33(170/130)
	Energy class ¹⁾	A+++ to D	A++/A++	A++/A++	A++/A++
Sound power ²⁾	Heat	dB(A)	52	53	54
Dimension / Net weight	H x W x D	mm / kg	996 x 980 x 430 / 98	996 x 980 x 430 / 98	996 x 980 x 430 / 97
Refrigerant (R290) / CO ₂ Eq.		kg / T	0,96/0,003	0,96/0,003	1,00/0,003
Operating range - outdoor ambient	Heat	°C	-25 ~ +35	-25 ~ +35	-25 ~ +35
	Cool	°C	+10 ~ +43	+10 ~ +43	+10 ~ +43
Water outlet	Heat / Cool	°C	20 ~ 75 / 5 ~ 20	20 ~ 75 / 5 ~ 20	20 ~ 75 / 5 ~ 20

1) Scale from A+++ to D. 2) The sound power level is measured with accordance to EN12102 under conditions of the EN14825 (part load). * EER and COP calculation is based in accordance to EN14511.



DHW A+: For All in One. INTERNET CONTROL: Wi-Fi adapter included.

All in One:

Energy efficiency: A+ in DHW / DHW up to 65 °C without heater / Stainless steel DHW tank with U-Vacua™ insulation panel / DHW COP 3,60.

Flexibility: Built-in 2 zone kit (for 2 zones models) / Installation in harsh water conditions (for models with Electrical Anode).

Control: Optimised user interface and improved features (2 zone control, bivalent control).

Connectivity: Wi-Fi adapter included.

Indoor unit			WH-ADC0509L3E5	WH-ADC0509L6E5
Indoor unit 2 zones			WH-ADC0509L3E5B	—
Indoor unit with Electrical Anode			WH-ADC0509L3E5AN	WH-ADC0509L6E5AN
Sound pressure	Heat / Cool	dB(A)	28/28	28/28
Dimension	H x W x D	mm	1642 x 599 x 602	1642 x 599 x 602
Net weight / 2 zones model		kg	93/101	94/—
Water pipe connector	Room	Inch	1¼	1¼
	Shower	Inch	¾	¾
A class pump	Number of speeds		Variable speed	Variable speed
	Input power (Min/Max)	W	30/145	30/145
Heating water flow (ΔT=5 K, 35 °C)		L/min	14,3	25,8
Water volume		L	185	185
Maximum DHW temperature		°C	65	65
Material inside tank			Stainless steel	Stainless steel
Water pipe connector (indoor / outdoor units)		Inch	1/1	1/1
Pipe length range standard / maximum		m	5/30	5/30
Elevation difference (in / out)		m	10	10
Electric backup heater		kW	3,00	6,00
Recommended RCD, supply 1 / 2		A	25/16	25/30
Recommended minimum cable size, supply 1 / 2 ¹¹		mm ²	3x2,5/3x1,5	3x2,5/3x4,0

Domestic Hot Water energy efficiency

Indoor unit	WH-ADC0509L3E5	WH-ADC0509L3E5	WH-ADC0509L3E5
	WH-ADC0509L3E5AN	WH-ADC0509L3E5AN	WH-ADC0509L3E5AN
Outdoor unit	WH-ADC0509L3E5B	WH-ADC0509L3E5B	WH-ADC0509L3E5B
	WH-ADC0509L6E5	WH-ADC0509L6E5	WH-ADC0509L6E5
	WH-ADC0509L6E5AN	WH-ADC0509L6E5AN	WH-ADC0509L6E5AN
Outdoor unit	WH-WDG05LE5	WH-WDG07LE5	WH-WDG09LE5
Tapping profile according EN16147	L	L	L
DHW tank ERP efficiency average / warm / cold ²¹	A+ to F	A+ / A+ / A	A+ / A+ / A
DHW tank ERP average climate η / COPdHW	η _{wh} % / COPdHW	148/3,61	148/3,61
DHW tank ERP warm climate η / COPdHW	η _{wh} % / COPdHW	160/4,00	160/4,00
DHW tank ERP cold climate η / COPdHW	η _{wh} % / COPdHW	112/2,80	112/2,80

1) Check local regulations. 2) Scale from A+ to F. ** This product is designed to comply with the European drinking water standard (EU) 2020/2184. The lifespan of the product is not guaranteed in the case of the use of groundwater, such as spring water or well water, the use of tap water when salt or other impurities are contained, nor in areas of acidic water quality. Maintenance and warranty costs related to these cases are the customer's responsibility.

Bi-bloc:

Flexibility: Flexible choice of DHW tank size.

Control: Optimised user interface and improved features (2 zone control, bivalent control).

Connectivity: Wi-Fi adapter included.

Indoor unit			WH-SDC0509L3E5	WH-SDC0509L6E5
Sound pressure	Heat / Cool	dB(A)	28/28	28/28
Dimension / Net weight	H x W x D	mm	892 x 500 x 348 / 33	892 x 500 x 348 / 33
Water pipe connector	Room	Inch	R 1¼	R 1¼
A class pump	Number of speeds		Variable speed	Variable speed
	Input power (Min/Max)	W	30/145	30/145
Heating water flow (ΔT=5 K, 35 °C)		L/min	14,3	20,1
Water pipe connector (indoor / outdoor units)		Inch	1/1	1/1
Pipe length range standard / maximum		m	5/30	5/30
Elevation difference (in / out)		m	10	10
Electric backup heater		kW	3,00	6,00
Recommended RCD, supply 1 / 2		A	25/16	25/30
Recommended minimum cable size, supply 1 / 2 ¹¹		mm ²	3x2,5/3x1,5	3x2,5/3x4,0

1) Check local regulations. ** This product is designed to comply with the European drinking water standard (EU) 2020/2184. The lifespan of the product is not guaranteed in the case of the use of groundwater, such as spring water or well water, the use of tap water when salt or other impurities are contained, nor in areas of acidic water quality. Maintenance and warranty costs related to these cases are the customer's responsibility.

Common accessories	
CZ-RTW1	Optional remote controller for 2 zone control. K and L Series
CZ-NS5P	PCB for advanced functions
PAW-A2W-RTWIRED	Room thermostat
PAW-A2W-RTWIRELESS	Wireless LCD room thermostat
PAW-A2W-AFVLV-1	1 antifreeze valve. It is required to order 2 valves per system

Bi-bloc accessories	
PAW-TD20C1E5-1	Tank 200 L - Stainless steel
PAW-TD30C1E5-1	Tank 300 L - Stainless steel
PAW-TA20C1E5STD	Tank 200 L - Enamelled
PAW-TA30C1E5STD	Tank 300 L - Enamelled
PAW-3WYVLV-HW	3 way valve for DHW tanks
CZ-NV2	3 way valve kit to fit inside the hydrokit. K and L Series
PAW-BTANK50L-2	Buffer tank 50 L

Aquarea High Performance Mono-bloc J Series Single phase. Heating and Cooling - MDC - R32

Energy efficiency: A+++ in heating at 35 °C / "A" water pump with variable speed / Built-in flow meter.

Flexibility: Built-in magnetic water filter / Built-in 6L expansion vessel.

Comfort: Operating range and heating curve down to -20 °C / 60 °C water outlet temperature / Cooling mode down to +10 °C.

Control: Additional functions with optional PCB (2 zone control, bivalent control, Smart Grid contact and more).

Connectivity: Optional Aquarea Smart and Service Cloud and integration into BMS projects.

011-1W0398
011-1W0399
011-1W0400

A++
ErP 55 °C
Scale from
A+++ to D

A+++
ErP 35 °C
Scale from
A+++ to D



Outdoor unit		Single phase			
		WH-MDC05J3E5	WH-MDC07J3E5	WH-MDC09J3E5	
Heating capacity / COP (A +7 °C, W 35 °C)	kW / COP	5,00/5,08	7,00/4,76	9,00/4,48	
Heating capacity / COP (A +7 °C, W 55 °C)	kW / COP	5,00/3,01	7,00/2,82	8,95/2,78	
Heating capacity / COP (A +2 °C, W 35 °C)	kW / COP	5,00/3,57	7,00/3,40	7,45/3,13	
Heating capacity / COP (A +2 °C, W 55 °C)	kW / COP	5,00/2,27	6,30/2,16	7,00/2,12	
Heating capacity / COP (A -7 °C, W 35 °C)	kW / COP	5,00/2,78	6,80/2,81	7,50/2,63	
Heating capacity / COP (A -7 °C, W 55 °C)	kW / COP	5,00/1,85	6,30/1,86	7,00/1,80	
Cooling capacity / EER (A 35 °C, W 7 °C)	kW / EER	5,00/3,31	7,00/3,06	9,00/2,71	
Cooling capacity / EER (A 35 °C, W 18 °C)	kW / EER	5,00/5,05	7,00/4,73	9,00/4,25	
Heating average climate (W 35 °C / W 55 °C)	Seasonal energy efficiency	SCOP (η _s %)	5,12/3,63(202/142)	4,90/3,32(193/130)	4,90/3,32(193/130)
	Energy class	A+++ to D	A+++/A++	A+++/A++	A+++/A++
Heating warm climate (W 35 °C / W 55 °C)	Seasonal energy efficiency	SCOP (η _s %)	6,00/4,20(237/165)	5,75/4,07(227/160)	5,75/4,07(227/160)
	Energy class	A+++ to D	A+++/A+++	A+++/A+++	A+++/A+++
Heating cold climate (W 35 °C / W 55 °C)	Seasonal energy efficiency	SCOP (η _s %)	4,08/2,95(160/115)	4,18/2,98(164/116)	4,18/2,98(164/116)
	Energy class	A+++ to D	A++/A+	A++/A+	A++/A+
Sound power ¹⁾	Heat	dB(A)	59	59	59
Dimension	HxWxD	mm	865x1283x320	865x1283x320	865x1283x320
Net weight		kg	99	104	104
Refrigerant (R32) / CO ₂ Eq. ²⁾		kg / T	1,3/0,878	1,3/0,878	1,3/0,878
Water pipe connector		Inch	R 1½	R 1½	R 1½
Pump	Number of speeds		Variable speed	Variable speed	Variable speed
	Input power (Min/Max)	W	34/96	36/100	39/108
Heating water flow (ΔT=5 K, 35 °C)		L/min	14,3	20,1	25,8
Electric backup heater		kW	3,00	3,00	3,00
Input power	Heat	kW	0,985	1,47	2,01
	Cool	kW	1,51	2,29	3,32
Running and starting current	Heat	A	4,7	7,0	9,3
	Cool	A	7,0	10,5	14,7
Current 1		A	12	17	17
Current 2		A	13	13	13
Recommended fuse		A	30/15	30/15	30/16
Recommended minimum cable size, supply 1 / 2 ³⁾		mm ²	3x1,5/3x1,5	3x2,5/3x1,5	3x2,5/3x1,5
Operating range - outdoor ambient	Heat	°C	-20 ~ -35	-20 ~ -35	-20 ~ -35
	Cool	°C	+10 ~ +43	+10 ~ +43	+10 ~ +43
Water outlet	Heat	°C	20 ~ 60	20 ~ 60	20 ~ 60
	Cool	°C	5 ~ 20	5 ~ 20	5 ~ 20

1) Sound power in accordance to 811/2013, 813/2013 and EN12102-1:2017 at +7 °C. 2) WH-MDC models are hermetically sealed. 3) Check local regulations. * EER and COP calculation is based in accordance to EN14511.

Accessories

PAW-TD20C1E5-1	Tank 200 L - Stainless steel
PAW-TD30C1E5-1	Tank 300 L - Stainless steel
PAW-TA20C1E5STD	Tank 200 L - Enamelled
PAW-TA30C1E5STD	Tank 300 L - Enamelled
PAW-TD20B8E3-2	Combo Tank 185 L + 80 L - Enamelled
PAW-TD23B6E5	Combo Tank 230 L + 60 L - Stainless steel
PAW-3WYVLV-HW	3 way valve for DHW tanks
PAW-BTANK50L-2	Buffer tank 50 L

Accessories

CZ-TAW1B	Aquarea Smart Cloud for remote control and maintenance through wireless or wired LAN
CZ-TAW1-CBL	10 m extension cable for CZ-TAW1B
PAW-A2W-AFVLV-1	1 antifreeze valve. It is required to order 2 valves per system
PAW-A2W-RTWIRED	Room thermostat
PAW-A2W-RTWIRELESS	Wireless LCD room thermostat



INTERNET CONTROL: Optional.

Aquarea High Performance Mono-bloc H Series Single phase. Heating and Cooling - MDC - R410A

Energy efficiency: A+++ in heating at 35 °C / "A" water pump with variable speed / Built-in flow meter.

Flexibility: Optional magnet for the water filter.

Comfort: Operating range and heating curve down to -20 °C / 55 °C water outlet temperature.

Control: Additional functions with optional PCB (2 zone control, bivalent control, Smart Grid contact and more).

Connectivity: Optional Aquarea Smart and Service Cloud and integration into BMS projects.

011-1W0509



Single phase

Outdoor unit			WH-MDC12H6E5	WH-MDC16H6E5
Heating capacity / COP (A +7 °C, W 35 °C)		kW / COP	12,00/4,74	16,00/4,28
Heating capacity / COP (A +7 °C, W 55 °C)		kW / COP	12,00/2,93	14,50/2,72
Heating capacity / COP (A +2 °C, W 35 °C)		kW / COP	11,40/3,44	13,00/3,28
Heating capacity / COP (A +2 °C, W 55 °C)		kW / COP	9,10/2,23	9,80/2,21
Heating capacity / COP (A -7 °C, W 35 °C)		kW / COP	10,00/2,73	11,40/2,57
Heating capacity / COP (A -7 °C, W 55 °C)		kW / COP	8,20/1,95	9,00/1,84
Cooling capacity / EER (A 35 °C, W 7 °C)		kW / EER	10,00/2,81	12,20/2,56
Cooling capacity / EER (A 35 °C, W 18 °C)		kW / EER	9,39/4,65	11,40/4,10
Heating average climate (W 35 °C / W 55 °C)	Seasonal energy efficiency	SCOP (η _s %)	4,82/3,42(190/134)	4,82/3,33(190/130)
	Energy class	A+++ to D	A+++/A++	A+++/A++
Heating warm climate (W 35 °C / W 55 °C)	Seasonal energy efficiency	SCOP (η _s %)	6,20/4,05(245/159)	6,20/4,30(245/169)
	Energy class	A+++ to D	A+++/A+++	A+++/A+++
Heating cold climate (W 35 °C / W 55 °C)	Seasonal energy efficiency	SCOP (η _s %)	4,28/3,10(168/121)	4,28/3,10(168/121)
	Energy class	A+++ to D	A++/A+	A++/A+
Sound power ¹⁾	Heat	dB(A)	65	65
Dimension	HxWxD	mm	1410x1283x320	1410x1283x320
Net weight		kg	140	140
Refrigerant (R410A) / CO ₂ Eq. ²⁾		kg / T	2,10/4,385	2,10/4,385
Water pipe connector		Inch	R1½	R1½
Pump	Number of speeds		Variable speed	Variable speed
	Input power (Min/Max)	W	34/110	38/120
Heating water flow (ΔT=5 K, 35 °C)		L/min	34,4	45,9
Electric backup heater		kW	6,00	6,00
Input power	Heat	kW	2,53	3,74
	Cool	kW	3,56	4,76
Running and starting current	Heat	A	11,7	16,9
	Cool	A	16,2	21,5
Current 1		A	24,0	26,0
Current 2		A	26,0	26,0
Recommended fuse		A	30/30	30/30
Recommended minimum cable size, supply 1 / 2 ³⁾		mm ²	3x4,0 ou 6,0/3x4,0	3x4,0 ou 6,0/3x4,0
Operating range - outdoor ambient	Heat	°C	-20 ~ +35	-20 ~ +35
	Cool	°C	+16 ~ +43	+16 ~ +43
Water outlet	Heat	°C	25 ~ 55	25 ~ 55
	Cool	°C	5 ~ 20	5 ~ 20

1) Sound power in accordance to 811/2013, 813/2013 and EN12102-1:2017 at +7 °C. 2) WH-MDC models are hermetically sealed. 3) Check local regulations. * EER and COP calculation is based in accordance to EN14511.

Accessories

PAW-TD20C1E5-1	Tank 200 L - Stainless steel
PAW-TD30C1E5-1	Tank 300 L - Stainless steel
PAW-TA20C1E5STD	Tank 200 L - Enamelled
PAW-TA30C1E5STD	Tank 300 L - Enamelled
PAW-TD20B8E3-2	Combo Tank 185 L + 80 L - Enamelled
PAW-TD23B6E5	Combo Tank 230 L + 60 L - Stainless steel
PAW-3WYVLV-HW	3 way valve for DHW tanks
PAW-BTANK50L-2	Buffer tank 50 L

Accessories

CZ-TAW1B	Aquarea Smart Cloud for remote control and maintenance through wireless or wired LAN
CZ-TAW1-CBL	10 m extension cable for CZ-TAW1B
PAW-A2W-MGTFILTER	Magnet for the water filter
PAW-A2W-AFVLV-1	1 antifreeze valve. It is required to order 2 valves per system
PAW-A2W-RTWIRED	Room thermostat
PAW-A2W-RTWIRELESS	Wireless LCD room thermostat



INTERNET CONTROL: Optional.

NEW Aquarea T-CAP Hydraulic M Series Single phase / Three phase. Heating and Cooling · R290

Natural refrigerant R290 with GWP 3.

Energy efficiency: A+++ in heating at 35 °C / Built-in flow meter.

Flexibility: Hydraulic connection between indoor and outdoor / Built-in magnetic water filter.

Comfort: Constant capacity down to -20 °C / Operation down to -28 °C / 75 °C water temperature at -15 °C outside / 55 °C hot water even at -25 °C outside temperature / Low noise level.

Control: Optimised user interface and improved features [2 zone control, bivalent control].



Tentative data

Indoor unit					Outdoor unit							
Backup heater capacity	DHW tank capacity	Electrical Anode	WH-	Heating capacity								
				Single phase		Three phase						
				9,0 kW	12,0 kW	9,0 kW	12,0 kW	16,0 kW	20,0 kW	25,0 kW	30,0 kW	
				WXG09ME5	WXG12ME5	WXG09ME8	WXG12ME8	WXG16ME8	WXG20ME8	WXG25ME8	WXG30ME8	
Hydraulic All in One	1ph	3 kW	185 L	—	WH-ADC0316M3E52	✓	✓	—	—	—	—	—
		3 kW	185 L	✓	WH-ADC0316M3E5AN2	✓	✓	—	—	—	—	—
	3ph	6 kW	185 L	—	WH-ADC0316M6E52	✓	✓	—	—	—	—	—
		9 kW	185 L	—	WH-ADC0316M9E82	✓	✓	✓	✓	—	—	—
Control module	—	—	—	—	WH-CME5	✓	✓	—	—	—	—	—
					WH-CME8	✓	✓	✓	✓	—	—	—
					WH-CME8L	—	—	—	—	✓	✓	✓
Remote controller with Wi-Fi adapter	—	—	—	—	CZ-RTW2TAW1C	✓	✓	✓	✓	✓	✓	

		Aquarea T-CAP M Series					Big Aquarea T-CAP M Series			
Outdoor unit		WH-	WXG09ME5	WXG12ME5	WXG09ME8	WXG12ME8	WXG16ME8	WXG20ME8	WXG25ME8	WXG30ME8
Heating capacity / COP (A +7 °C, W 35 °C)	kW / COP		9,00/5,23	12,00/5,06	9,00/5,23	12,00/5,06	16,00/4,89	20,00/4,66	25,00/4,40	30,00/4,36
Heating capacity / COP (A +7 °C, W 55 °C)	kW / COP		9,00/3,24	12,00/3,23	9,00/3,24	12,00/3,23	16,00/3,20	20,00/3,18	25,00/3,00	30,00/3,00
Heating capacity / COP (A +2 °C, W 35 °C)	kW / COP		9,00/3,81	12,00/3,54	9,00/3,81	12,00/3,54	16,00/3,30	20,00/3,39	25,00/3,21	30,00/2,98
Heating capacity / COP (A +2 °C, W 55 °C)	kW / COP		9,00/2,54	12,00/2,42	9,00/2,54	12,00/2,42	16,00/2,37	20,00/2,08	25,00/1,96	30,00/1,95
Heating capacity / COP (A -7 °C, W 35 °C)	kW / COP		9,00/3,45	12,00/3,00	9,00/3,45	12,00/3,00	16,00/2,53	20,00/2,48	25,00/2,35	30,00/2,32
Heating capacity / COP (A -7 °C, W 55 °C)	kW / COP		9,00/2,35	12,00/2,17	9,00/2,35	12,00/2,17	16,00/1,97	20,00/1,60	25,00/1,51	30,00/1,49
Cooling capacity / EER (A 35 °C, W 7 °C)	kW / EER		9,00/3,61	9,00/3,61	9,00/3,61	9,00/3,61	9,00/3,61	20,00/3,12	25,00/2,95	30,00/2,02
Cooling capacity / EER (A 35 °C, W 18 °C)	kW / EER		9,00/5,26	12,00/5,26	9,00/5,26	12,00/5,26	16,00/5,26	20,00/3,58	25,00/3,44	30,00/3,31
Heating average climate (W 35 °C / W 55 °C)	Seasonal energy efficiency	SCOP (η _s %)	4,96/3,57 (195/140)	5,00/3,46 (197/135)	4,96/3,57 (195/140)	5,00/3,46 (197/135)	4,20/3,31 (168/129)			
	Energy class ¹⁾	A+++ to D	A+++/A++	A+++/A++	A+++/A++	A+++/A++	A+++/A++			
Heating warm climate (W 35 °C / W 55 °C)	Seasonal energy efficiency	SCOP (η _s %)	6,47/4,34 (256/171)	6,47/4,34 (256/171)	6,47/4,34 (256/171)	6,47/4,34 (256/171)	5,88/4,09 (232/160)			
	Energy class ¹⁾	A+++ to D	A+++/A+++	A+++/A+++	A+++/A+++	A+++/A+++	A+++/A+++			
Heating cold climate (W 35 °C / W 55 °C)	Seasonal energy efficiency	SCOP (η _s %)	4,31/3,26 (169/127)	4,31/3,26 (169/127)	4,31/3,26 (169/127)	4,31/3,26 (169/127)	3,83/3,20 (150/125)			
	Energy class ¹⁾	A+++ to D	A++/A++	A++/A++	A++/A++	A++/A++	A++/A++			
Sound power ²⁾	Heat	dB(A)	52	53	52	53	57	60	60	62
Dimension	H x W x D	mm	1340 x 900 x 320	1340 x 900 x 320	1691 x 1315 x 604	1691 x 1315 x 604	1691 x 1315 x 604	1645 x 1500 x 460	1645 x 1500 x 460	1645 x 1500 x 460
Net weight		kg	161	161	161	161	165	260	260	260
A class pump	Number of speeds		Variable speed	Variable speed	Variable speed	Variable speed	Variable speed			
	Input power (Min/Max)	W	30/175	30/175	30/175	30/175	30/175			
Heating water flow (ΔT=5 K, 35 °C)		L/min	25,8	34,4	25,8	34,4	45,9			
Refrigerant (R290) / CO ₂ Eq. ³⁾		kg / T	1,78/0,006	1,78/0,006	1,78/0,006	1,78/0,006	1,77/0,006	2,6/0,008	2,6/0,008	2,6/0,008
Operating range - outdoor ambient	Heat	°C	-28 ~ +35	-28 ~ +35	-28 ~ +35	-28 ~ +35	-28 ~ +35	-25 ~ +35	-25 ~ +35	-25 ~ +35
	Cool	°C	+10 ~ +43	+10 ~ +43	+10 ~ +43	+10 ~ +43	+10 ~ +43	+10 ~ +43	+10 ~ +43	+10 ~ +43
Water outlet	Heat / Cool	°C	25 ~ 75 / 5 ~ 20	25 ~ 75 / 5 ~ 20	25 ~ 75 / 5 ~ 20	25 ~ 75 / 5 ~ 20	25 ~ 75 / 5 ~ 20	20 ~ 75 / 5 ~ 20	20 ~ 75 / 5 ~ 20	20 ~ 75 / 5 ~ 20
Recommended RCD, supply		A	30	30	20	20	25			
Recommended minimum cable size, supply ¹⁾		mm ²	3x4,0	3x4,0	5x1,5	5x1,5	5x2,5			

1) Scale from A+++ to D. 2) Sound power level in accordance to EN12102 under conditions of the EN14825. 3) WH-WXG models are hermetically sealed. 4) Check local regulations.* EER and COP classification is at 230 V only in accordance with EU directive 2003/32/EC.



DHW A+: For All in One. INTERNET CONTROL: Wi-Fi adapter included.

All in One:

Energy efficiency: A+ in DHW / DHW up to 65 °C without heater / Stainless steel DHW tank with U-Vacua™ insulation panel / DHW COP up to 3,60.

Flexibility: Backup heater included / Built-in 10 L expansion vessel / 30 m maximum height difference between indoor and outdoor / Installation in harsh water conditions (for models with Electrical Anode).

Control: All control functions / 2 CN-CNT ports / Optional PCB for advanced functions.

Connectivity: Wi-Fi adapter included / Optional integration into BMS.

Indoor unit			WH-ADC0316M3E52	WH-ADC0316M6E52	WH-ADC0316M9E82
Indoor unit with Electrical Anode			WH-ADC0316M3E5AN2	—	WH-ADC0316M9E8AN2
Sound pressure	Heat / Cool	dB(A)	22/22	22/22	22/22
Dimension	H x W x D	mm	1642 x 599 x 602	1642 x 599 x 602	1642 x 599 x 602
Net weight		kg	89	89	89
Water pipe connector	Room	Inch	1¼	1¼	1¼
	Shower	Inch	¾	¾	¾
Water volume		L	185	185	185
Maximum DHW temperature		°C	65	65	65
Material inside tank			Stainless steel	Stainless steel	Stainless steel
Water pipe connector (indoor / outdoor units)		Inch	1¼ / 1¼	1¼ / 1¼	1¼ / 1¼
Pipe length range standard / maximum		m	5 / 30	5 / 30	5 / 30
Elevation difference (in / out)		m	30	30	30
Electric backup heater		kW	3,00	6,00	9,00
Recommended RCD, supply		A	16	30	20
Recommended minimum cable size, supply ¹⁾		mm ²	3x1,5	3x4,0	5x1,5
Connecting cable to the outdoor unit size		mm ²	2x0,75	2x0,75	2x0,75

Domestic Hot Water energy efficiency

Indoor unit	WH-	ADC0316M3E52	ADC0316M3E52	ADC0316M9E82	ADC0316M9E82	ADC0316M9E82
		ADC0316M3E5AN2	ADC0316M3E5AN2	ADC0316M9E8AN2	ADC0316M9E8AN2	ADC0316M9E8AN2
Outdoor unit		WH-WXG09ME5	WH-WXG12ME5	WH-WXG09ME8	WH-WXG12ME8	WH-WXG16ME8
Tapping profile according EN16147		L	L	L	L	L
DHW tank ERP efficiency average / warm / cold ²⁾	A+ to F	A+ / A+ / A	A+ / A+ / A	A+ / A+ / A	A+ / A+ / A	A+ / A+ / A
DHW tank ERP average climate η / COPdHW	$\eta_{wh} \%$ / COPdHW	123 / 3,00	123 / 3,00	123 / 3,00	123 / 3,00	117 / 2,85
DHW tank ERP warm climate η / COPdHW	$\eta_{wh} \%$ / COPdHW	132 / 3,30	132 / 3,30	132 / 3,30	132 / 3,30	128 / 3,20
DHW tank ERP cold climate η / COPdHW	$\eta_{wh} \%$ / COPdHW	88 / 2,20	88 / 2,20	88 / 2,20	88 / 2,20	84 / 2,10

1) Check local regulations. 2) Scale from A+ to F. ** This product is designed to comply with the European drinking water standard (EU) 2020/2184. The lifespan of the product is not guaranteed in the case of the use of groundwater, such as spring water or well water, the use of tap water when salt or other impurities are contained, nor in areas of acidic water quality. Maintenance and warranty costs related to these cases are the customer's responsibility.

Control module:

Flexibility: Simplified installation / Minimal interior space required / Supports third-party backup heater.

Control: All control functions / 2 CN-CNT ports / Optional PCB for advanced functions.

Connectivity: Wi-Fi adapter included / Optional integration into BMS.

Indoor unit			WH-CME5	WH-CME8	WH-CME8L
Dimension	H x W x D	mm	450 x 450 x 117	450 x 450 x 117	450 x 450 x 117
Net weight		kg	7	7	7
Field supply electrical backup heater		kW	Up to 3 kW	Up to 9 kW	
Recommended RCD, supply		A	16	30	20
Recommended minimum cable size, supply ¹⁾		mm ²	3x1,5	3x4,0	5x1,5
Connecting cable to the outdoor unit size		mm ²	2x0,75	2x0,75	

1) Check local regulations.

Common accessories

CZ-RTW2TAW1C	Remote controller with Wi-Fi adapter (required for stand-alone outdoor units). M Series
CZ-RTW2	Optional remote controller for 2 zone control. M Series
CZ-NS6P	PCB for advanced functions. M Series All in One and Bi-bloc
CZ-NS7P	PCB for advanced functions. M Series control module
PAW-A2W-RTWIRED	Room thermostat
PAW-A2W-RTWIRELESS	Wireless LCD room thermostat
PAW-A2W-AFVLV-1	1 antifreeze valve. It is required to order 2 valves per system

Bi-bloc accessories

PAW-TD20C1E5-1	Tank 200 L - Stainless steel
PAW-TD30C1E5-1	Tank 300 L - Stainless steel
PAW-TA20C1E5STD	Tank 200 L - Enamelled
PAW-TA30C1E5STD	Tank 300 L - Enamelled
PAW-3WYVLV-HW	3 way valve for DHW tanks
PAW-BTANK50L-2	Buffer tank 50 L
PAW-BTANK100L	Buffer tank 100 L
PAW-BTANKG200L	Buffer tank 200 L
PAW-BTANKG260L	Buffer tank 260 L

Aquarea T-CAP Mono-bloc J Series Single phase / Three phase. Heating and Cooling - MXC · R32

Energy efficiency: A+++ in heating at 35 °C / "A" water pump with variable speed / Built-in flow meter.

Flexibility: Built-in magnetic water filter.

Comfort: Constant capacity and operating range down to -20 °C / 65 °C water outlet temperature.

Control: Additional functions with optional PCB (2 zone control, bivalent control, Smart Grid contact and more).

Connectivity: Optional Aquarea Smart and Service Cloud and integration into BMS projects.

011-1W0463, 011-1W0464, 011-1W0562,
011-1W0563, 011-1W0564, 011-1W0565.
For 9 and 12 kW single and three phase.



Outdoor unit	Single phase			Three phase			
	WH-MXC09J3E5	WH-MXC12J6E5	WH-MXC09J3E8	WH-MXC12J9E8	WH-MXC16J9E8		
Heating capacity / COP (A +7 °C, W 35 °C)	kW / COP	9,00/5,08	12,00/4,80	9,00/5,08	12,00/4,80	16,00/4,52	
Heating capacity / COP (A +7 °C, W 55 °C)	kW / COP	9,00/3,08	12,00/3,05	9,00/3,08	12,00/3,05	16,00/2,86	
Heating capacity / COP (A +2 °C, W 35 °C)	kW / COP	9,00/3,81	12,00/3,53	9,00/3,81	12,00/3,53	16,00/3,10	
Heating capacity / COP (A +2 °C, W 55 °C)	kW / COP	9,00/2,54	12,00/2,42	9,00/2,54	12,00/2,42	16,00/2,07	
Heating capacity / COP (A -7 °C, W 35 °C)	kW / COP	9,00/3,08	12,00/2,82	9,00/3,08	12,00/2,82	16,00/2,39	
Heating capacity / COP (A -7 °C, W 55 °C)	kW / COP	9,00/2,12	12,00/2,00	9,00/2,12	12,00/2,00	16,00/1,71	
Cooling capacity / EER (A 35 °C, W 7 °C)	kW / EER	9,00/3,18	12,00/2,90	9,00/3,09	12,00/2,84	14,50/2,84	
Cooling capacity / EER (A 35 °C, W 18 °C)	kW / EER	9,00/4,62	12,00/3,95	9,00/4,46	12,00/3,79	16,00/3,75	
Heating average climate (W 35 °C / W 55 °C)	Seasonal energy efficiency	SCOP (η _s %)	4,96/3,57(195/140)	4,96/3,57(195/140)	4,96/3,57(195/140)	4,96/3,57(195/140)	4,46/3,31(176/129)
	Energy class ¹⁾		A+++ / A++	A+++ / A++	A+++ / A++	A+++ / A++	A+++ / A++
Heating warm climate (W 35 °C / W 55 °C)	Seasonal energy efficiency	SCOP (η _s %)	6,47/4,34(256/171)	6,47/4,34(256/171)	6,47/4,34(256/171)	6,47/4,34(256/171)	5,88/4,09(232/160)
	Energy class ¹⁾		A+++ / A+++	A+++ / A+++	A+++ / A+++	A+++ / A+++	A+++ / A+++
Heating cold climate (W 35 °C / W 55 °C)	Seasonal energy efficiency	SCOP (η _s %)	4,31/3,26(169/127)	4,31/3,26(169/127)	4,31/3,26(169/127)	4,31/3,26(169/127)	3,83/3,20(150/125)
	Energy class ¹⁾		A+++ / A++	A++ / A++	A++ / A++	A++ / A++	A++ / A++
Sound power ²⁾	Heat	dB(A)	61	61	61	61	63
Dimension	HxWxD	mm	1410x1283x320	1410x1283x320	1410x1283x320	1410x1283x320	1410x1283x320
Net weight		kg	140	140	140	140	150
Refrigerant (R32) / CO ₂ Eq. ³⁾		kg / T	1,60/1,080	1,60/1,080	1,60/1,080	1,60/1,080	1,80/1,215
Water pipe connector		Inch	R 1½	R 1½	R 1½	R 1½	R 1½
Pump	Number of speeds		Variable speed	Variable speed	Variable speed	Variable speed	Variable speed
	Input power (Min/Max)	W	32/145	34/145	145	145	145
Heating water flow (ΔT=5 K, 35 °C)		L/min	25,8	34,4	25,8	34,4	45,9
Electric backup heater		kW	3,00	6,00	3,00	9,00	9,00
Input power	Heat	kW	1,77	2,50	1,77	2,50	3,54
	Cool	kW	2,83	4,14	2,91	4,23	5,11
Running and starting current	Heat	A	8,3	11,6	2,6	3,7	5,3
	Cool	A	13,1	19,1	4,3	6,3	7,6
Current 1		A	29,0	29,0	14,7	11,8	16,4
Current 2		A	13,0	26,0	13,0	13,0	13,0
Recommended fuse, supply 1 / 2		A	30/30	30/30	20/16	20/20	20/20
Recommended minimum cable size, supply 1 / 2 ⁴⁾		mm ²	3x4,0/3x4,0	3x4,0/3x4,0	5x1,5/3x1,5	5x1,5/5x1,5	5x2,5/5x1,5
Operating range - outdoor ambient	Heat	°C	-20 ~ +35	-20 ~ +35	-20 ~ +35	-20 ~ +35	-20 ~ +35
	Cool	°C	10 ~ +43	10 ~ +43	10 ~ +43	10 ~ +43	10 ~ +43
Water outlet ⁵⁾	Heat	°C	20 ~ 65	20 ~ 65	20 ~ 65	20 ~ 65	20 ~ 65
	Cool	°C	5 ~ 20	5 ~ 20	5 ~ 20	5 ~ 20	5 ~ 20

1) Scale from A+++ to D. 2) Sound power level in accordance to EN12102 under conditions of the EN14825. 3) WH-MXC models are hermetically sealed. 4) Check local regulations. 5) It is possible to set temperature by 65 °C on remote controller. Normally, outlet water temperature is 60 °C or lower. In case of ΔT setting with remote controller is 15 °C and the outdoor ambient temperature is 5 to 20 °C, outlet water temperature 65 °C is possible. * EER and COP calculation is based in accordance to EN14511.

Accessories	
PAW-TD20C1E5-1	Tank 200 L - Stainless steel
PAW-TD30C1E5-1	Tank 300 L - Stainless steel
PAW-TA20C1E5STD	Tank 200 L - Enamelled
PAW-TA30C1E5STD	Tank 300 L - Enamelled
PAW-TD20B8E3-2	Combo Tank 185 L + 80 L - Enamelled
PAW-TD23B6E5	Combo Tank 230 L + 60 L - Stainless steel
PAW-3WYVLV-HW	3 way valve for DHW tanks
PAW-BTANK50L-2	Buffer tank 50 L

Accessories	
CZ-TAW1B	Aquarea Smart Cloud for remote control and maintenance through wireless or wired LAN
CZ-TAW1-CBL	10 m extension cable for CZ-TAW1B
PAW-A2W-AFVLV-1	1 antifreeze valve. It is required to order 2 valves per system
PAW-A2W-RTWIRED	Room thermostat
PAW-A2W-RTWIRELESS	Wireless LCD room thermostat



INTERNET CONTROL: Optional.

Aquarea EcoFlex. Single phase. Heating and Cooling · R32

Energy efficiency: Heat recovery function, to re-use wasted heat of outdoor unit for DHW production.

Flexibility: Small foot print outdoor unit, tank unit with a standard size of appliances.

Comfort: Non-stop heating operation / nanoe™ X technology to improve protection 24/7 (nanoe X Generator Mark 2).

Connectivity: Wi-Fi adapter included via Aquarea Smart Cloud or Panasonic Comfort Cloud App.



WH-ADF0309J3E5CM

Air to water	Heating capacity / COP [A +7 °C, W 35 °C]		kW / COP	8,00/4,21	
	Heating capacity / COP [A +7 °C, W 55 °C]		kW / COP	8,00/2,81	
	Heating capacity / COP [A +2 °C, W 35 °C]		kW / COP	6,70/3,25	
	Heating capacity / COP [A +2 °C, W 55 °C]		kW / COP	6,00/2,08	
	Heating capacity / COP [A -7 °C, W 35 °C]		kW / COP	5,60/2,84	
	Heating capacity / COP [A -7 °C, W 55 °C]		kW / COP	5,30/1,91	
	Cooling capacity / EER [A 35 °C, W 7 °C]		kW / EER	—	
	Cooling capacity / EER [A 35 °C, W 18 °C]		kW / EER	—	
	Heating average climate (W 35 °C / W 55 °C)	Seasonal energy efficiency	SCOP (η _s %)		4,00/3,20 [157 / 125]
		Energy class ¹⁾		A+++ to D	A++/A++
	Heating warm climate (W 35 °C / W 55 °C)	Seasonal energy efficiency	SCOP (η _s %)		5,69/3,69 [224 / 145]
		Energy class ¹⁾		A+++ to D	A+++/A++
	Heating cold climate (W 35 °C / W 55 °C)	Seasonal energy efficiency	SCOP (η _s %)		3,61/2,80 [141 / 109]
		Energy class ¹⁾		A+++ to D	A+/A+
	Sound pressure	Heat / Cool		dB(A)	28 / —
	Dimension / Net weight	HxWxD		mm / kg	1880x598x600/108
	Electric backup heater			kW	3,00
	Water volume			L	185
	Maximum DHW temperature			°C	65
	Heating water flow [ΔT=5 K, 35 °C]			L/min	22,90
Tapping profile according EN16147				L	
DHW tank ERP efficiency average / warm / cold ²⁾				A+ to F	
DHW tank ERP average climate η / COPdhw			η _{wh} % / COPdhw	104/2,60	
DHW tank ERP warm climate η / COPdhw			η _{wh} % / COPdhw	134/3,35	
DHW tank ERP cold climate η / COPdhw			η _{wh} % / COPdhw	92/2,30	
Heat recovery capacity (DHW 55 °C)			kW	7,10+9,00	
Heat recovery input power (DHW 55 °C)			kW	3,15	
Heat recovery COP (DHW 55 °C)				5,11	
Water outlet			°C	20 - 55	

S-71WF3E

Air to air	Cooling capacity	Nominal	kW	7,10	
	EER ³⁾	Nominal	W/W	3,40	
	SEER ⁴⁾			5,60 A+	
	Pdesign (cooling)			7,10	
	Heating capacity	Nominal	kW	7,10	
	COP ³⁾	Nominal	W/W	3,90	
	SCOP ⁴⁾			3,90 A	
	Pdesign at -10 °C		kW	4,80	
	External static pressure ⁵⁾		Pa	30 [10 - 150]	
	Air flow		m ³ /min	22,7	
	Sound pressure ⁶⁾	Cool / Heat (Hi)		dB(A)	34 / 34
	Sound power ⁷⁾	Cool / Heat (Hi)		dB(A)	57 / 57
	Dimension / Net weight	HxWxD		mm / kg	250x1000x730/30
	nanoe X Generator				Mark 2

CU-2WZ71YBE5

Outdoor unit	Sound pressure	Cool / Heat (air to air)		dB(A)	49/49
	Sound power ⁷⁾	Cool / Heat (air to air)		dB(A)	68/67
	Sound pressure	Heat (air to water)		dB(A)	51
	Sound power ⁸⁾	Heat (air to water)		dB(A)	61
	Dimension / Net weight	HxWxD		mm / kg	999x940x340/82
	Refrigerant (R32) / CO ₂ , Eq.			kg / T	2,40/1,62
	Piping diameter	Liquid / Gas		Inch (mm)	1/4 (6,35) / 1/2 (12,70)
	Pipe length range / Elevation difference (in / out)			m / m	35/30
	Pre-charged pipe length / Additional gas amount			m / g/m	30/20
	Operating range - outdoor ambient	Heat (air to air)		°C	-15 ~ +24
		Cool (air to air)		°C	-10 ~ +46
		Heat (air to water)		°C	-15 ~ +35
		Heat recovery (floor / DHW)		°C	+10 ~ +35 / +10 ~ +46

1) Scale from A+++ to D. 2) Scale from A+ to F. 3) EER and COP calculation is based in accordance to EN14511. 4) SEER and SCOP is calculated based on values of EU/626/2011. 5) Medium external static pressure setting from factory. 6) The sound pressure of the units shows the value measured of the position 1,5 m below the unit. The sound pressure is measured in accordance with Eurovent 6/C/006-97 specification. 7) Sound power is measured in accordance with EN14511 and EN12102-1:2017 at +7 °C. 8) Sound power in accordance to 811/2013, 813/2013 and EN12102-1:2017 at +7 °C.



INTERNET CONTROL: Wi-Fi adapter included

Aquarea K Series

Aquarea K Generation gives you even more.

Highly efficient Panasonic solutions can help to significantly reduce the energy consumption of the house, at the same time a high level of comfort and good indoor air quality are kept.



Ventilation unit on top for a low-energy house

Heat recovery ventilation units are ideal for homes, for these owners who are looking for high performance and maximum comfort.

Combine the Residential ventilation unit with Panasonic Aquarea for an space saving and highly efficient solution for heating, cooling, ventilation and DHW.

Aquarea + PV panels

Aquarea Heat Pumps can synchronise with PV panels, using the optional PCB CZ-NS5P. Thanks to this feature, demand of heating, cooling and domestic hot water production is adapted to the PV panel production.

Smart Grid Ready

Aquarea K Generation heat pumps in combination with the optional PCB CZ-NS5P hold the SG Ready function, allowing the heat pump to be connected in an intelligent grid control.

Remote controller designed in harmony with the whole system, with optimised user interface and improved features.

Smart bivalency.

Cost effective bivalent mode with power tariff logic.

Optimised user interface.

Each touch point designed in harmony, with optimised user interface across the range.

Dual controller system.

A dual controller system, for independent control of two zones, within the home.



Aquarea High Performance All in One K Series Single phase. Heating and Cooling · R32

Energy efficiency: COP up to 5,33 / A+++ in heating at 35 °C and A+ in DHW / "A" water pump with variable speed / Stainless steel DHW tank with U-Vacua™ insulation panel / DHW COP up to 3,50.

Flexibility: 598 x 600 footprint / Easy access to hydraulic parts / Built-in magnetic water filter.

Comfort: Operation without backup heating at -25 °C / 60 °C hot water even at -10 °C outside temperature.

Control: Optimised user interface and improved features (2 zone control, bivalent control).

Connectivity: Optional Aquarea Smart and Service Cloud and integration into BMS projects.



		Single phase (power to indoor)							
Kit 3 kW electric heater		KIT-ADC03K3E5	KIT-ADC05K3E5	KIT-ADC07K3E5	KIT-ADC09K3E5	—			
Kit 6 kW electric heater		KIT-ADC03K6E5	KIT-ADC05K6E5	KIT-ADC07K6E5	KIT-ADC09K6E5	KIT-ADC12K6E5*			
Heating capacity / COP (A +7 °C, W 35 °C)	kW / COP	3,20/5,33	5,00/5,10	7,00/4,86	9,00/4,55	12,10/4,78			
Heating capacity / COP (A +7 °C, W 55 °C)	kW / COP	3,20/2,81	5,00/3,03	7,00/2,92	8,90/2,93	12,00/2,96			
Heating capacity / COP (A +2 °C, W 35 °C)	kW / COP	3,20/3,64	5,00/3,57	6,85/3,43	7,00/3,40	11,50/3,44			
Heating capacity / COP (A +2 °C, W 55 °C)	kW / COP	3,20/2,19	5,00/2,29	6,25/2,23	6,30/2,18	9,20/2,25			
Heating capacity / COP (A -7 °C, W 35 °C)	kW / COP	3,30/2,80	5,00/2,79	5,75/2,95	6,25/2,84	10,10/2,74			
Heating capacity / COP (A -7 °C, W 55 °C)	kW / COP	3,20/1,79	5,00/1,89	5,35/1,98	5,90/1,93	8,40/1,97			
Cooling capacity / EER (A 35 °C, W 7 °C)	kW / EER	3,20/3,52	5,00/3,05	6,70/3,03	8,20/2,72	10,70/2,68			
Cooling capacity / EER (A 35 °C, W 18 °C)	kW / EER	3,20/4,71	5,00/4,90	6,70/4,72	9,00/4,18	10,70/3,92			
Heating average climate (W 35 °C / W 55 °C)	Seasonal energy efficiency	SCOP (η _s %)	5,07/3,47(200/136)	5,12/3,63(202/142)	4,90/3,62(193/142)	4,44/3,41(175/133)	4,58/3,33(180/130)		
	Energy class ¹⁾	A+++ to D	A+++ / A++	A+++ / A++	A+++ / A++	A+++ / A++	A+++ / A++		
Heating warm climate (W 35 °C / W 55 °C)	Seasonal energy efficiency	SCOP (η _s %)	6,20/4,20(245/165)	6,00/4,20(237/165)	5,75/4,07(227/160)	5,75/4,07(227/160)	6,47/4,34(256/171)		
	Energy class ¹⁾	A+++ to D	A+++ / A+++	A+++ / A+++	A+++ / A+++	A+++ / A+++	A+++ / A+++		
Heating cold climate (W 35 °C / W 55 °C)	Seasonal energy efficiency	SCOP (η _s %)	4,00/2,83(157/110)	4,08/2,95(160/115)	4,18/2,98(164/116)	4,18/2,98(164/116)	4,31/3,26(169/127)		
	Energy class ¹⁾	A+++ to D	A++ / A+	A++ / A+	A++ / A+	A++ / A+	A++ / A++		
Indoor unit 3 kW electric heater		WH-ADC0309K3E5	WH-ADC0309K3E5	WH-ADC0309K3E5	WH-ADC0309K3E5	—			
Indoor unit 6 kW electric heater		WH-ADC0309K6E5	WH-ADC0309K6E5	WH-ADC0309K6E5	WH-ADC0309K6E5	WH-ADC0912K6E5			
Sound pressure	Heat / Cool	dB(A)	28/28	28/28	28/28	28/28	33/33		
Dimension	H x W x D	mm	1642 x 599 x 602	1642 x 599 x 602	1642 x 599 x 602	1642 x 599 x 602	1642 x 599 x 602		
Net weight 3 kW / 6 kW		kg	100/101	100/101	100/101	100/101	—/101		
Water pipe connector		Inch	R 1¼	R 1¼	R 1¼	R 1¼	R 1¼		
A class pump	Number of speeds		Variable speed	Variable speed	Variable speed	Variable speed	Variable speed		
	Input power	W	145	145	145	145	145		
Heating water flow (ΔT=5 K, 35 °C)		L/min	9,2	14,3	20,1	25,8	34,4		
Water volume		L	185	185	185	185	185		
Maximum DHW temperature		°C	65	65	65	65	65		
Material inside tank			Stainless steel	Stainless steel	Stainless steel	Stainless steel	Stainless steel		
Tapping profile according EN16147			L	L	L	L	L		
DHW tank ERP efficiency average / warm / cold ²⁾	A+ to F	A+ / A++ / A	A+ / A++ / A	A+ / A++ / A	A+ / A++ / A	A+ / A++ / A	A+ / A / A		
DHW tank ERP average climate η / COP _{DHW}	η _{wh} % / COP _{DHW}	128/3,20	140/3,50	140/3,50	140/3,50	100/2,50			
DHW tank ERP warm climate η / COP _{DHW}	η _{wh} % / COP _{DHW}	154/3,86	160/4,00	160/4,00	160/4,00	116/2,90			
DHW tank ERP cold climate η / COP _{DHW}	η _{wh} % / COP _{DHW}	99/2,48	112/2,80	112/2,80	112/2,80	80/2,00			
Outdoor unit		WH-UDZ03KE5	WH-UDZ05KE5	WH-UDZ07KE5	WH-UDZ09KE5	WH-UDZ12KE5			
Sound power ³⁾	Heat	dB(A)	55	55	56	56	65		
Dimension / Net weight	H x W x D	mm / kg	622 x 824 x 298 / 37	795 x 875 x 380 / 55	795 x 875 x 380 / 55	795 x 875 x 380 / 55	1340 x 900 x 320 / 88		
Refrigerant (R32) / CO ₂ Eq.	kg / T		0,9/0,608	1,3/0,878	1,3/0,878	1,3/0,878	1,6/1,080		
Piping diameter	Liquid / Gas	Inch (mm)	1/4(6,35)/1/2(12,70)	1/4(6,35)/5/8(15,88)	1/4(6,35)/5/8(15,88)	1/4(6,35)/5/8(15,88)	1/4(6,35)/1/2(12,7)		
Pipe length range / Elevation difference (in / out)	m / m		3-25/20	3-40(3-50) ⁴⁾ / 30	3-40(3-50) ⁴⁾ / 30	3-40(3-50) ⁴⁾ / 30	3-30(3-50) ⁴⁾ / 20(30) ⁵⁾		
Pre-charged pipe length / Additional gas amount	m / g/m		10/20	10/25	10/25	10/25	10/30		
Operating range - outdoor ambient	Heat	°C	-20 ~ +35	-25 ~ +35	-25 ~ +35	-25 ~ +35	-25 ~ +35		
	Cool	°C	+10 ~ +43	+10 ~ +43	+10 ~ +43	+10 ~ +43	+10 ~ +43		
Water outlet ⁶⁾	Heat / Cool	°C	20 ~ 60/5 ~ 20	20 ~ 60/5 ~ 20	20 ~ 60/5 ~ 20	20 ~ 60/5 ~ 20	20 ~ 60/5 ~ 20		
Electrical information		Heater	3 kW	6 kW	3 kW	6 kW	3 kW	6 kW	6 kW
Electric backup heater	kW	3,00	6,00	3,00	6,00	3,00	6,00	3,00	6,00
Recommended fuse	A	16/16	16/30	16/16	16/30	25/16	25/30	25/16	25/30
Recommended minimum cable size, supply 1 / 2 ⁷⁾	mm ²	3x1,5/ 3x1,5	3x1,5/ 3x4,0	3x1,5/ 3x1,5	3x1,5/ 3x4,0	3x2,5/ 3x4,0	3x2,5/ 3x4,0	3x1,5/ 3x4,0	3x4,0/3x4,0

1) Scale from A+++ to D. 2) Scale from A+ to F. 3) Sound power level in accordance to EN12102 under conditions of the EN14825. 4) Operation range down to -25 °C in heating with 3-40 m pipe length range, operation range down to -15 °C in heating with 3-50 m pipe length range. 5) Ambient temperature down to -10 °C. Below -10 °C, permitted piping length and elevation difference is 3-30 m, 20 m. 6) Between outdoor ambient -10 °C and -15 °C, the water outlet temperature gradually decreases from 60 °C to 55 °C. 7) Check local regulations. * Available in Summer 2024. Tentative data. ** EER and COP classification is at 230 V only in accordance with EU directive 2003/32/EC. *** This product is designed to comply with the European drinking water standard (EU) 2020/2184. The lifespan of the product is not guaranteed in the case of the use of groundwater, such as spring water or well water, the use of tap water when salt or other impurities are contained, nor in areas of acidic water quality. Maintenance and warranty costs related to these cases are the customer's responsibility.

Accessories	
CZ-RTW1	Optional remote controller for 2 zone control. K and L Series
CZ-TAW1B	Aquarea Smart Cloud for remote control and maintenance through wireless or wired LAN

Accessories	
CZ-TAW1-CBL	10 m extension cable for CZ-TAW1B
CZ-NS5P	PCB for advanced functions
PAW-A2W-RTWIRED	Room thermostat
PAW-A2W-RTWIREDLESS	Wireless LCD room thermostat



INTERNET CONTROL: Optional.

NEW Aquarea High Performance All in One K Series Three phase. Heating and Cooling - R32

Energy efficiency: A+++ in heating at 35 °C and A+ in DHW / "A" water pump with variable speed / Stainless steel DHW tank with U-Vacua™ insulation panel.

Flexibility: 598 x 600 footprint / Easy access to hydraulic parts / Built-in magnetic water filter.

Comfort: Operation without backup heating at -25 °C / 60 °C hot water even at -10 °C outside temperature.

Control: Optimised user interface and improved features [2 zone control, bivalent control].

Connectivity: Optional Aquarea Smart and Service Cloud and integration into BMS projects.



New
2024



Three phase (power to indoor)						
Kit			KIT-ADC09K9E8	KIT-ADC12K9E8	KIT-ADC16K9E8	
Heating capacity / COP (A +7 °C, W 35 °C)			kW / COP	9,00/4,90	12,10/4,78	16,00/4,31
Heating capacity / COP (A +7 °C, W 55 °C)			kW / COP	9,00/2,97	12,00/2,96	14,70/2,72
Heating capacity / COP (A +2 °C, W 35 °C)			kW / COP	9,00/3,63	11,50/3,44	13,20/3,28
Heating capacity / COP (A +2 °C, W 55 °C)			kW / COP	9,00/2,26	9,20/2,25	10,00/2,21
Heating capacity / COP (A -7 °C, W 35 °C)			kW / COP	9,00/2,88	10,10/2,74	11,60/2,57
Heating capacity / COP (A -7 °C, W 55 °C)			kW / COP	8,10/2,07	8,40/1,97	9,10/1,85
Cooling capacity / EER (A 35 °C, W 7 °C)			kW / EER	8,80/3,11	10,70/2,68	13,40/2,64
Cooling capacity / EER (A 35 °C, W 18 °C)			kW / EER	8,80/4,63	10,70/3,92	15,50/3,60
Heating average climate (W 35 °C / W 55 °C)	Seasonal energy efficiency	SCOP (η _s %)	4,96/3,57(195/140)	4,58/3,33(180/130)	4,46/3,40(176/133)	
	Energy class ¹⁾		A+++ to D	A+++/A++	A+++/A++	
Heating warm climate (W 35 °C / W 55 °C)	Seasonal energy efficiency	SCOP (η _s %)	6,47/4,34(256/171)	6,47/4,34(256/171)	6,20/4,30(245/169)	
	Energy class ¹⁾		A+++ to D	A+++/A+++	A+++/A+++	
Heating cold climate (W 35 °C / W 55 °C)	Seasonal energy efficiency	SCOP (η _s %)	4,31/3,26(169/127)	4,31/3,26(169/127)	4,28/3,10(168/121)	
	Energy class ¹⁾		A+++ to D	A++/A++	A++/A+	
Indoor unit			WH-ADC0912K9E8	WH-ADC0912K9E8	WH-ADC16K9E8	
Sound pressure	Heat / Cool	dB(A)	33/33	33/33	33/33	
Dimension	HxWxD	mm	1642x599x602	1642x599x602	1642x599x602	
Net weight 3 kW / 6 kW		kg	102	102	103	
Water pipe connector		Inch	R 1½	R 1½	R 1½	
A class pump	Number of speeds		Variable speed	Variable speed	Variable speed	
	Input power	W	145	145	145	
Heating water flow (ΔT=5 K, 35 °C)		L/min	25,8	34,4	45,9	
Water volume		L	185	185	185	
Maximum DHW temperature		°C	65	65	65	
Material inside tank			Stainless steel	Stainless steel	Stainless steel	
Tapping profile according EN16147			L	L	L	
DHW tank ERP efficiency average / warm / cold ²⁾		A+ to F	A/A+/A	A/A+/A	A/A+/A	
DHW tank ERP average climate η / COPdHW		η _{wh} % / COPdHW	100/2,50	100/2,50	96/2,40	
DHW tank ERP warm climate η / COPdHW		η _{wh} % / COPdHW	116/2,90	116/2,90	115/2,88	
DHW tank ERP cold climate η / COPdHW		η _{wh} % / COPdHW	80/2,00	80/2,00	76/1,90	
Outdoor unit			WH-UDZ09KE8	WH-UDZ12KE8	WH-UDZ16KE8	
Sound power ³⁾	Heat	dB(A)	65	65	65	
Dimension / Net weight	HxWxD	mm / kg	1340x900x320/90	1340x900x320/90	1340x900x320/103	
Refrigerant (R32) / CO ₂ Eq.		kg / T	1,60/1,080	1,60/1,080	1,83/1,235	
Piping diameter	Liquid / Gas	Inch (mm)	1/4 (6,35)/1/2 (12,70)	1/4 (6,35)/1/2 (12,70)	1/4 (6,35)/1/2 (12,70)	
Pipe length range / Elevation difference (in / out)		m / m	3~30/20	3~30/20	3~30/20	
Pre-charged pipe length / Additional gas amount		m / g/m	10/30	10/30	10/30	
Operating range - outdoor ambient	Heat	°C	-25~+35	-25~+35	-25~+35	
	Cool	°C	+10~+43	+10~+43	+10~+43	
Water outlet ⁴⁾	Heat / Cool	°C	20~60/5~20	20~60/5~20	20~60/5~20	
Electrical information			WH-ADC0912K9E8	WH-ADC0912K9E8	WH-ADC16K9E8	
Electric backup heater		kW	9,00	9,00	9,00	
Recommended fuse		A	20/20	20/20	20/20	
Recommended minimum cable size, supply 1 / 2 ⁵⁾		mm ²	5x1,5/5x1,5	5x1,5/5x1,5	5x2,5/5x1,5	

1) Scale from A+++ to D. 2) Scale from A+ to F. 3) Sound power level in accordance to EN12102 under conditions of the EN14825. 4) Between outdoor ambient -10 °C and -15 °C, the water outlet temperature gradually decreases from 60 °C to 55 °C. 5) Check local regulations. * EER and COP classification is at 230 V only in accordance with EU directive 2003/32/EC. ** This product is designed to comply with the European drinking water standard (EU) 2020/2184. The lifespan of the product is not guaranteed in the case of the use of groundwater, such as spring water or well water, the use of tap water when salt or other impurities are contained, nor in areas of acidic water quality. Maintenance and warranty costs related to these cases are the customer's responsibility. *** Available in Summer 2024. Tentative data.

Accessories	
CZ-RTW1	Optional remote controller for 2 zone control. K and L Series
CZ-TAW1B	Aquarea Smart Cloud for remote control and maintenance through wireless or wired LAN

Accessories	
CZ-TAW1-CBL	10 m extension cable for CZ-TAW1B
CZ-NS5P	PCB for advanced functions
PAW-A2W-RTWIRED	Room thermostat
PAW-A2W-RTWIRELESS	Wireless LCD room thermostat



INTERNET CONTROL: Optional.

Aquarea High Performance All in One K Series Single phase. Heating and Cooling 2 zones - R32

Energy efficiency: COP up to 5,33 / A+++ in heating at 35 °C and A+ in DHW / "A" water pump with variable speed / Stainless steel DHW tank with U-Vacua™ insulation panel / DHW COP up to 3,50.

Flexibility: 598 x 600 footprint / Easy access to hydraulic parts / Built-in magnetic water filter / 2 zone control.

Comfort: Operation without backup heating at -25 °C / 60 °C hot water even at -10 °C outside temperature.

Control: Optimised user interface and improved features (2 zone control, bivalent control).

Connectivity: Optional Aquarea Smart and Service Cloud and integration into BMS projects.



		Single phase (power to indoor)			
Kit		KIT-ADC03K3E5B	KIT-ADC05K3E5B	KIT-ADC07K3E5B	KIT-ADC09K3E5B
Heating capacity / COP (A +7 °C, W 35 °C)	kW / COP	3,20/5,33	5,00/5,10	7,00/4,86	9,00/4,55
Heating capacity / COP (A +7 °C, W 55 °C)	kW / COP	3,20/2,81	5,00/3,03	7,00/2,92	8,90/2,93
Heating capacity / COP (A +2 °C, W 35 °C)	kW / COP	3,20/3,64	5,00/3,57	6,85/3,43	7,00/3,40
Heating capacity / COP (A +2 °C, W 55 °C)	kW / COP	3,20/2,19	5,00/2,29	6,25/2,23	6,30/2,18
Heating capacity / COP (A -7 °C, W 35 °C)	kW / COP	3,30/2,80	5,00/2,79	5,75/2,95	6,25/2,84
Heating capacity / COP (A -7 °C, W 55 °C)	kW / COP	3,20/1,79	5,00/1,89	5,35/1,98	5,90/1,93
Cooling capacity / EER (A 35 °C, W 7 °C)	kW / EER	3,20/3,52	5,00/3,05	6,70/3,03	8,20/2,72
Cooling capacity / EER (A 35 °C, W 18 °C)	kW / EER	3,20/4,71	5,00/4,90	6,70/4,72	9,00/4,18
Heating average climate (W 35 °C / W 55 °C)	Seasonal energy efficiency SCOP (η _s %)	5,07/3,47(200/136)	5,12/3,63(202/142)	4,90/3,62(193/142)	4,44/3,41(175/133)
	Energy class ¹⁾	A+++ to D	A+++/A++	A+++/A++	A+++/A++
Heating warm climate (W 35 °C / W 55 °C)	Seasonal energy efficiency SCOP (η _s %)	6,20/4,20(245/165)	6,00/4,20(237/165)	5,75/4,07(227/160)	5,75/4,07(227/160)
	Energy class ¹⁾	A+++ to D	A+++/A+++	A+++/A+++	A+++/A+++
Heating cold climate (W 35 °C / W 55 °C)	Seasonal energy efficiency SCOP (η _s %)	4,00/2,83(157/110)	4,08/2,95(160/115)	4,18/2,98(164/116)	4,18/2,98(164/116)
	Energy class ¹⁾	A+++ to D	A++/A+	A++/A+	A++/A+
Indoor unit		WH-ADC0309K3E5B	WH-ADC0309K3E5B	WH-ADC0309K3E5B	WH-ADC0309K3E5B
Sound pressure	Heat / Cool	dB(A)	28/28	28/28	28/28
Dimension	H x W x D	mm	1642 x 599 x 602	1642 x 599 x 602	1642 x 599 x 602
Net weight		kg	109	109	109
Water pipe connector		Inch	R 1¼	R 1¼	R 1¼
A class pump	Number of speeds		Variable speed	Variable speed	Variable speed
	Input power (Min/Max)	W	30/120	30/120	30/120
Heating water flow (ΔT=5 K, 35 °C)		L/min	9,2	14,3	20,1
Water volume		L	185	185	185
Maximum DHW temperature		°C	65	65	65
Material inside tank			Stainless steel	Stainless steel	Stainless steel
Tapping profile according EN16147			L	L	L
DHW tank ERP efficiency average / warm / cold ²⁾		A+ to F	A+/A++/A	A+/A++/A	A+/A++/A
DHW tank ERP average climate η / COP _{DHW}	η _{wh} % / COP _{DHW}		128/3,20	140/3,50	140/3,50
DHW tank ERP warm climate η / COP _{DHW}	η _{wh} % / COP _{DHW}		154/3,86	160/4,00	160/4,00
DHW tank ERP cold climate η / COP _{DHW}	η _{wh} % / COP _{DHW}		99/2,48	112/2,80	112/2,80
Outdoor unit		WH-UDZ03KE5	WH-UDZ05KE5	WH-UDZ07KE5	WH-UDZ09KE5
Sound power ³⁾	Heat	dB(A)	55	55	56
Dimension / Net weight	H x W x D	mm / kg	622 x 824 x 298/37	795 x 875 x 380/55	795 x 875 x 380/55
Refrigerant (R32) / CO ₂ Eq.		kg / T	0,9/0,608	1,3/0,878	1,3/0,878
Piping diameter	Liquid / Gas	Inch (mm)	1/4(6,35)/1/2(12,70)	1/4(6,35)/5/8(15,88)	1/4(6,35)/5/8(15,88)
Pipe length range / Elevation difference (in / out)		m / m	3 ~ 25/20	3 ~ 40(3 ~ 50) ⁴⁾ /30	3 ~ 40(3 ~ 50) ⁴⁾ /30
Pre-charged pipe length / Additional gas amount		m / g/m	10/20	10/25	10/25
Operating range - outdoor ambient	Heat	°C	-20 ~ +35	-25 ~ +35	-25 ~ +35
	Cool	°C	+10 ~ +43	+10 ~ +43	+10 ~ +43
Water outlet	Heat / Cool	°C	20 ~ 60/5 ~ 20	20 ~ 60/5 ~ 20	20 ~ 60/5 ~ 20
Electrical information		WH-ADC0309K3E5B	WH-ADC0309K3E5B	WH-ADC0309K3E5B	WH-ADC0309K3E5B
Electric backup heater		kW	3,00	3,00	3,00
Recommended fuse		A	16/16	16/16	25/16
Recommended minimum cable size, supply 1 / 2 ⁵⁾		mm ²	3x1,5/3x1,5	3x1,5/3x1,5	3x2,5/3x1,5

1) Scale from A+++ to D. 2) Scale from A+ to F. 3) Sound power in accordance to 811/2013, 813/2013 and EN12102-1:2017 at +7 °C. 4) Operation range down to -25 °C in heating with 3 ~ 40 m pipe length range, operation range down to -15 °C in heating with 3 ~ 50 m pipe length range. 5) Check local regulations. * EER and COP calculation is based in accordance to EN14511. ** This product is designed to comply with the European drinking water standard (EU) 2020/2184. The lifespan of the product is not guaranteed in the case of the use of groundwater, such as spring water or well water, the use of tap water when salt or other impurities are contained, nor in areas of acidic water quality. Maintenance and warranty costs related to these cases are the customer's responsibility.

Accessories	
CZ-RTW1	Optional remote controller for 2 zone control. K and L Series
CZ-TAW1B	Aquarea Smart Cloud for remote control and maintenance through wireless or wired LAN

Accessories	
CZ-TAW1-CBL	10 m extension cable for CZ-TAW1B
CZ-NS5P	PCB for advanced functions
PAW-A2W-RTWIRED	Room thermostat
PAW-A2W-RTWIRELESS	Wireless LCD room thermostat



INTERNET CONTROL: Optional.

Aquarea High Performance All in One K Series Single phase. Heating and Cooling with Electrical Anode · R32

Energy efficiency: COP up to 5,33 / A+++ in heating at 35 °C and A+ in DHW / "A" water pump with variable speed / Stainless steel DHW tank with U-Vacua™ insulation panel / DHW COP up to 3,50.

Flexibility: 598 x 600 footprint / Built-in magnetic water filter / Installation possible in sites with harsh water quality.

Comfort: Operation without backup heating at -25 °C / 60 °C hot water even at -10 °C outside temperature.

Control: Optimised user interface and improved features [2 zone control, bivalent control].

Connectivity: Optional Aquarea Smart and Service Cloud and integration into BMS projects.



		Single phase (power to indoor)						
Kit 3 kW electric heater		KIT-ADC03K3E5AN	KIT-ADC05K3E5AN	KIT-ADC07K3E5AN	KIT-ADC09K3E5AN	—		
Kit 6 kW electric heater		KIT-ADC03K6E5AN	KIT-ADC05K6E5AN	KIT-ADC07K6E5AN	KIT-ADC09K6E5AN	KIT-ADC12K6E5AN*		
Heating capacity / COP (A +7 °C, W 35 °C)	kW / COP	3,20/5,33	5,00/5,10	7,00/4,86	9,00/4,55	12,10/4,78		
Heating capacity / COP (A +7 °C, W 55 °C)	kW / COP	3,20/2,81	5,00/3,03	7,00/2,92	8,90/2,93	12,00/2,96		
Heating capacity / COP (A +2 °C, W 35 °C)	kW / COP	3,20/3,64	5,00/3,57	6,85/3,43	7,00/3,40	11,50/3,44		
Heating capacity / COP (A +2 °C, W 55 °C)	kW / COP	3,20/2,19	5,00/2,29	6,25/2,23	6,30/2,18	9,20/2,25		
Heating capacity / COP (A -7 °C, W 35 °C)	kW / COP	3,30/2,80	5,00/2,79	5,75/2,95	6,25/2,84	10,10/2,74		
Heating capacity / COP (A -7 °C, W 55 °C)	kW / COP	3,20/1,79	5,00/1,89	5,35/1,98	5,90/1,93	8,40/1,97		
Cooling capacity / EER (A 35 °C, W 7 °C)	kW / EER	3,20/3,52	5,00/3,05	6,70/3,03	8,20/2,72	10,70/2,68		
Cooling capacity / EER (A 35 °C, W 18 °C)	kW / EER	3,20/4,71	5,00/4,90	6,70/4,72	9,00/4,18	10,70/3,92		
Heating average climate (W 35 °C / W 55 °C)	Seasonal energy efficiency	SCOP (η _s %)	5,07/3,47(200/136)	5,12/3,63(202/142)	4,90/3,62(193/142)	4,44/3,41(175/133)	4,58/3,33(180/130)	
	Energy class ¹⁾	A+++ to D	A+++/A++	A+++/A++	A+++/A++	A+++/A++	A+++/A++	
Heating warm climate (W 35 °C / W 55 °C)	Seasonal energy efficiency	SCOP (η _s %)	6,20/4,20(245/165)	6,00/4,20(237/165)	5,75/4,07(227/160)	5,75/4,07(227/160)	6,47/4,34(256/171)	
	Energy class ¹⁾	A+++ to D	A+++/A+++	A+++/A+++	A+++/A+++	A+++/A+++	A+++/A+++	
Heating cold climate (W 35 °C / W 55 °C)	Seasonal energy efficiency	SCOP (η _s %)	4,00/2,83(157/110)	4,08/2,95(160/115)	4,18/2,98(164/116)	4,18/2,98(164/116)	4,31/3,26(169/127)	
	Energy class ¹⁾	A+++ to D	A++/A+	A++/A+	A++/A+	A++/A+	A++/A++	
Indoor unit 3 kW electric heater	WH-	ADC0309K3E5AN	ADC0309K3E5AN	ADC0309K3E5AN	ADC0309K3E5AN	—		
Indoor unit 6 kW electric heater	WH-	ADC0309K6E5AN	ADC0309K6E5AN	ADC0309K6E5AN	ADC0309K6E5AN	ADC0912K6E5AN		
Sound pressure	Heat / Cool	dB(A)		28/28	28/28	28/28	33/33	
Dimension	HxWxD	mm		1642x599x602	1642x599x602	1642x599x602	1642x599x602	
Net weight		kg		100/101	100/101	100/101	- / 101	
Water pipe connector		Inch		R1¼	R1¼	R1¼	R1¼	
A class pump	Number of speeds	Variable speed		Variable speed	Variable speed	Variable speed	Variable speed	
	Input power	W		145	145	145	145	
Heating water flow (ΔT=5 K, 35 °C)		L/min		9,2	14,3	20,1	25,8	
Water volume		L		185	185	185	185	
Maximum DHW temperature		°C		65	65	65	65	
Material inside tank		Stainless steel		Stainless steel	Stainless steel	Stainless steel	Stainless steel	
Tapping profile according EN16147		L		L	L	L	L	
DHW tank ERP efficiency average / warm / cold ²⁾	A+ to F	A+/A++/A		A+/A++/A	A+/A++/A	A+/A++/A	A+/A/A	
DHW tank ERP average climate η / COPdHW	η _{wh} % / COPdHW	128/3,20		140/3,50	140/3,50	140/3,50	100/2,50	
DHW tank ERP warm climate η / COPdHW	η _{wh} % / COPdHW	154/3,86		160/4,00	160/4,00	160/4,00	116/2,90	
DHW tank ERP cold climate η / COPdHW	η _{wh} % / COPdHW	99/2,48		112/2,80	112/2,80	112/2,80	80/2,00	
Outdoor unit	WH-UDZ03KE5	WH-UDZ05KE5	WH-UDZ07KE5	WH-UDZ09KE5	WH-UDZ12KE5			
Sound power ³⁾	Heat	dB(A)		55	55	56	56	
Dimension / Net weight	HxWxD	mm / kg		622x824x298/37	795x875x380/55	795x875x380/55	795x875x380/55	
Refrigerant (R32) / CO ₂ Eq.	kg / T	0,9/0,608		1,3/0,878	1,3/0,878	1,3/0,878	1,6/1,080	
Piping diameter	Liquid / Gas	Inch (mm)		1/4(6,35)/1/2(12,70)	1/4(6,35)/5/8(15,88)	1/4(6,35)/5/8(15,88)	1/4(6,35)/1/2(12,7)	
Pipe length range / Elevation difference (in / out)	m / m	3 ~ 25/20		3 ~ 40(3 ~ 50) ⁴⁾ /30	3 ~ 40(3 ~ 50) ⁴⁾ /30	3 ~ 40(3 ~ 50) ⁴⁾ /30	3 ~ 30(3 ~ 50) ⁵⁾ /20(30) ⁶⁾	
Pre-charged pipe length / Additional gas amount	m / g/m	10/20		10/25	10/25	10/25	10/30	
Operating range - outdoor ambient	Heat	°C		-20 ~ +35	-25 ~ +35	-25 ~ +35	-25 ~ +35	
	Cool	°C		+10 ~ +43	+10 ~ +43	+10 ~ +43	+10 ~ +43	
Water outlet ⁴⁾	Heat / Cool	°C		20 ~ 60/5 ~ 20	20 ~ 60/5 ~ 20	20 ~ 60/5 ~ 20	20 ~ 60/5 ~ 20	
Electrical information	Heater	3 kW	6 kW	3 kW	6 kW	3 kW	6 kW	6 kW
Electric backup heater	kW	3,00	6,00	3,00	6,00	3,00	6,00	6,00
Recommended fuse	A	16/16	16/30	16/16	16/30	25/16	25/30	25/30
Recommended minimum cable size, supply 1 / 2 ⁷⁾	mm ²	3x1,5/ 3x1,5	3x1,5/ 3x4,0	3x1,5/ 3x1,5	3x1,5/ 3x4,0	3x2,5/ 3x4,0	3x2,5/ 3x4,0	3x4,0/3x4,0

1) Scale from A+++ to D. 2) Scale from A+ to F. 3) Sound power level in accordance to EN12102 under conditions of the EN14825. 4) Operation range down to -25 °C in heating with 3 ~ 40 m pipe length range, operation range down to -10 °C in heating with 3 ~ 50 m pipe length range. 5) Ambient temperature down to -10 °C. Below -10 °C, permitted piping length and elevation difference is 3 ~ 30 m, 20 m. 6) Between outdoor ambient -10 °C and -15 °C, the water outlet temperature gradually decreases from 60 °C to 55 °C. 7) Check local regulations. * Available in Summer 2024. Tentative data. ** EER and COP classification is at 230 V only in accordance with EU directive 2003/32/EC. *** This product is designed to comply with the European drinking water standard (EU) 2020/2184. The lifespan of the product is not guaranteed in the case of the use of groundwater, such as spring water or well water, the use of tap water when salt or other impurities are contained, nor in areas of acidic water quality. Maintenance and warranty costs related to these cases are the customer's responsibility.

Accessories	
CZ-RTW1	Optional remote controller for 2 zone control. K and L Series
CZ-TAW1B	Aquarea Smart Cloud for remote control and maintenance through wireless or wired LAN

Accessories	
CZ-TAW1-CBL	10 m extension cable for CZ-TAW1B
CZ-NS5P	PCB for advanced functions
PAW-A2W-RTWIRED	Room thermostat
PAW-A2W-RTWIREDLESS	Wireless LCD room thermostat



INTERNET CONTROL: Optional.

NEW Aquarea High Performance All in One K Series Three phase. Heating and Cooling with Electrical Anode · R32

Energy efficiency: A+++ in heating at 35 °C and A+ in DHW / "A" water pump with variable speed / Stainless steel DHW tank with U-Vacua™ insulation panel.

Flexibility: 598 x 600 footprint / Easy access to hydraulic parts / Built-in magnetic water filter / Installation possible in sites with harsh water quality.

Comfort: Operation without backup heating at -25 °C / 60 °C hot water even at -10 °C outside temperature.

Control: Optimised user interface and improved features (2 zone control, bivalent control).

Connectivity: Optional Aquarea Smart and Service Cloud and integration into BMS projects.



Kit		Three phase (power to indoor)			
Kit		KIT-ADC09K9E8AN*	KIT-ADC12K9E8AN*	KIT-ADC16K9E8AN*	
Heating capacity / COP (A +7 °C, W 35 °C)	kW / COP	9,00/4,90	12,10/4,78	16,00/4,31	
Heating capacity / COP (A +7 °C, W 55 °C)	kW / COP	9,00/2,97	12,00/2,96	14,70/2,72	
Heating capacity / COP (A +2 °C, W 35 °C)	kW / COP	9,00/3,63	11,50/3,44	13,20/3,28	
Heating capacity / COP (A +2 °C, W 55 °C)	kW / COP	9,00/2,26	9,20/2,25	10,00/2,21	
Heating capacity / COP (A -7 °C, W 35 °C)	kW / COP	9,00/2,88	10,10/2,74	11,60/2,57	
Heating capacity / COP (A -7 °C, W 55 °C)	kW / COP	8,10/2,07	8,40/1,97	9,10/1,85	
Cooling capacity / EER (A 35 °C, W 7 °C)	kW / EER	8,80/3,11	10,70/2,68	13,40/2,64	
Cooling capacity / EER (A 35 °C, W 18 °C)	kW / EER	8,80/4,63	10,70/3,92	15,50/3,60	
Heating average climate (W 35 °C / W 55 °C)	Seasonal energy efficiency	SCOP (η _s %)	4,96/3,57(195/140)	4,58/3,33(180/130)	4,46/3,40(176/133)
	Energy class ¹⁾	A+++ to D	A+++/A++	A+++/A++	A+++/A++
Heating warm climate (W 35 °C / W 55 °C)	Seasonal energy efficiency	SCOP (η _s %)	6,47/4,34(256/171)	6,47/4,34(256/171)	6,20/4,30(245/169)
	Energy class ¹⁾	A+++ to D	A+++/A+++	A+++/A+++	A+++/A+++
Heating cold climate (W 35 °C / W 55 °C)	Seasonal energy efficiency	SCOP (η _s %)	4,31/3,26(169/127)	4,31/3,26(169/127)	4,28/3,10(168/121)
	Energy class ¹⁾	A+++ to D	A++/A++	A++/A++	A++/A+
Indoor unit		WH-ADC0912K9E8AN	WH-ADC0912K9E8AN	WH-ADC16K9E8AN	
Sound pressure	Heat / Cool	dB(A)	33/33	33/33	
Dimension	H x W x D	mm	1642 x 599 x 602	1642 x 599 x 602	
Net weight		kg	102	103	
Water pipe connector		Inch	R 1/4	R 1/4	
A class pump	Number of speeds		Variable speed	Variable speed	
	Input power	W	145	145	
Heating water flow (ΔT=5 K, 35 °C)		L/min	25,8	34,4	
Water volume		L	185	185	
Maximum DHW temperature		°C	65	65	
Material inside tank			Stainless steel	Stainless steel	
Tapping profile according EN16147			L	L	
DHW tank ERP efficiency average / warm / cold ²⁾	A+ to F	A/A+/A	A/A+/A	A/A+/A	
DHW tank ERP average climate η / COPdHW	η _{wh} % / COPdHW	100/2,50	100/2,50	96/2,40	
DHW tank ERP warm climate η / COPdHW	η _{wh} % / COPdHW	116/2,90	116/2,90	115/2,88	
DHW tank ERP cold climate η / COPdHW	η _{wh} % / COPdHW	80/2,00	80/2,00	76/1,90	
Outdoor unit		WH-UDZ09KE8	WH-UDZ12KE8	WH-UDZ16KE8	
Sound power ³⁾	Heat	dB(A)	65	65	
Dimension / Net weight	H x W x D	mm / kg	1340 x 900 x 320/90	1340 x 900 x 320/90	
Refrigerant (R32) / CO ₂ Eq.		kg / T	1,60/1,080	1,60/1,080	
Piping diameter	Liquid / Gas	Inch (mm)	1/4(6,35)/1/2(12,70)	1/4(6,35)/1/2(12,70)	
Pipe length range / Elevation difference (in / out)		m / m	3-30/20	3-30/20	
Pre-charged pipe length / Additional gas amount		m / g/m	10/30	10/30	
Operating range - outdoor ambient	Heat	°C	-25 ~ +35	-25 ~ +35	
	Cool	°C	+10 ~ +43	+10 ~ +43	
Water outlet ⁴⁾	Heat / Cool	°C	20 ~ 60/5 ~ 20	20 ~ 60/5 ~ 20	
Electrical information		WH-ADC0912K9E8	WH-ADC0912K9E8	WH-ADC16K9E8	
Electric backup heater		kW	9,00	9,00	
Recommended fuse		A	20/20	20/20	
Recommended minimum cable size, supply 1 / 2 ⁵⁾		mm ²	5x1,5/5x1,5	5x1,5/5x1,5	

1) Scale from A+++ to D. 2) Scale from A+ to F. 3) Sound power level in accordance to EN12102 under conditions of the EN14825. 4) Between outdoor ambient -10 °C and -15 °C, the water outlet temperature gradually decreases from 60 °C to 55 °C. 5) Check local regulations. * Available in Summer 2024. Tentative data. ** EER and COP classification is at 230 V only in accordance with EU directive 2003/32/EC. *** This product is designed to comply with the European drinking water standard (EU) 2020/2184. The lifespan of the product is not guaranteed in the case of the use of groundwater, such as spring water or well water, the use of tap water when salt or other impurities are contained, nor in areas of acidic water quality. Maintenance and warranty costs related to these cases are the customer's responsibility.

Accessories	
CZ-RTW1	Optional remote controller for 2 zone control. K and L Series
CZ-TAW1B	Aquarea Smart Cloud for remote control and maintenance through wireless or wired LAN

Accessories	
CZ-TAW1-CBL	10 m extension cable for CZ-TAW1B
CZ-NS5P	PCB for advanced functions
PAW-A2W-RTWIRED	Room thermostat
PAW-A2W-RTWIREDLESS	Wireless LCD room thermostat



INTERNET CONTROL: Optional.

Aquarea High Performance All in One Compact H Series Single phase. Heating and Cooling - R410A

Energy efficiency: A+++ in heating at 35 °C and A in DHW / "A" water pump with variable speed / Stainless steel DHW tank with U-Vacua™ insulation panel / Built-in flow meter.

Flexibility: 598 x 600 footprint / Built-in magnetic water filter.

Comfort: Operating range down to -20 °C.

Control: Additional functions with optional PCB (2 zone control, bivalent control, Smart Grid contact and more).

Connectivity: Optional Aquarea Smart and Service Cloud and integration into BMS projects.

011-1W0515



Single phase (power to indoor)					
Kit		KIT-ADC12HE5C		KIT-ADC16HE5C	
Heating capacity / COP (A +7 °C, W 35 °C)		kW / COP		12,00/4,74	
Heating capacity / COP (A +7 °C, W 55 °C)		kW / COP		12,00/2,93	
Heating capacity / COP (A +2 °C, W 35 °C)		kW / COP		11,40/3,44	
Heating capacity / COP (A +2 °C, W 55 °C)		kW / COP		9,10/2,20	
Heating capacity / COP (A -7 °C, W 35 °C)		kW / COP		10,00/2,73	
Heating capacity / COP (A -7 °C, W 55 °C)		kW / COP		8,20/1,92	
Cooling capacity / EER (A 35 °C, W 7 °C)		kW / EER		10,00/2,81	
Cooling capacity / EER (A 35 °C, W 18 °C)		kW / EER		10,00/4,17	
Heating average climate (W 35 °C / W 55 °C)		Seasonal energy efficiency SCOP (η _s , %)		4,82/3,42(190/134)	
		Energy class ¹⁾		A+++ to D	
Heating warm climate (W 35 °C / W 55 °C)		Seasonal energy efficiency SCOP (η _s , %)		6,21/4,05(245/159)	
		Energy class ¹⁾		A+++ to D	
Heating cold climate (W 35 °C / W 55 °C)		Seasonal energy efficiency SCOP (η _s , %)		4,29/3,10(168/121)	
		Energy class ¹⁾		A+++ to D	
Indoor unit		WH-ADC1216H6E5C		WH-ADC1216H6E5C	
Sound pressure		Heat / Cool		dB(A)	
				33/33	
Dimension		HxWxD		mm	
				1642x599x602	
Net weight				kg	
				101	
Water pipe connector				Inch	
				R 1¼	
A class pump		Number of speeds		Variable speed	
		Input power (Min/Max)		W	
				—/—	
Heating water flow (ΔT=5 K, 35 °C)				L/min	
				34,40	
Electric backup heater				kW	
				6,00	
Recommended fuse				A	
				—/—	
Recommended minimum cable size, supply 1 / 2 ²⁾				mm ²	
				—/—	
Water volume				L	
				185	
Maximum DHW temperature				°C	
				65	
Material inside tank					
				Stainless steel	
Tapping profile according EN16147					
				—	
DHW tank ERP efficiency average / warm / cold ³⁾				A+ to F	
				—/—/—	
DHW tank ERP average climate η / COPdHW				η _{wh} % / COPdHW	
				92/2,30	
DHW tank ERP warm climate η / COPdHW				η _{wh} % / COPdHW	
				107/2,67	
DHW tank ERP cold climate η / COPdHW				η _{wh} % / COPdHW	
				72/1,81	
Outdoor unit		WH-UD12HE5		WH-UD16HE5	
Sound power ⁴⁾				dB(A)	
				65	
Dimension / Net weight		HxWxD		mm / kg	
				1340x900x320/101	
Refrigerant (R410A) / CO ₂ Eq.				kg / T	
				2,55/5,324	
Piping diameter		Liquid / Gas		Inch (mm)	
				3/8 (9,52)/5/8 (15,88)	
Pipe length range / Elevation difference (in / out)				m / m	
				3 - 50/30	
Pre-charged pipe length / Additional gas amount				m / g/m	
				10/50	
Operating range - outdoor ambient		Heat		°C	
		Cool		°C	
				-20 ~ +35	
				+16 ~ +43	
Water outlet		Heat / Cool		°C	
				20 ~ 55/5 ~ 20	

1) Scale from A+++ to D. 2) Check local regulations. 3) Scale from A+ to F. 4) Sound power in accordance to 811/2013, 813/2013 and EN12102-1:2017 at +7 °C. * EER and COP calculation is based in accordance to EN14511. ** This product is designed to comply with the European drinking water standard (EU) 2020/2184. The lifespan of the product is not guaranteed in the case of the use of groundwater, such as spring water or well water, the use of tap water when salt or other impurities are contained, nor in areas of acidic water quality. Maintenance and warranty costs related to these cases are the customer's responsibility.

Accessories	
CZ-TAW1B	Aquarea Smart Cloud for remote control and maintenance through wireless or wired LAN
CZ-TAW1-CBL	10 m extension cable for CZ-TAW1B

Accessories	
CZ-NS4P	PCB for advanced functions
PAW-A2W-RTWIRED	Room thermostat
PAW-A2W-RTWIRELESS	Wireless LCD room thermostat



INTERNET CONTROL: Optional.

Aquarea High Performance All in One H Series Three phase. Heating and Cooling · R410A

Energy efficiency: A+++ in heating at 35 °C and A+ in DHW / "A" water pump with variable speed / Stainless steel DHW tank with U-Vacua™ insulation panel / Built-in flow meter.

Flexibility: Optional magnet for the water filter.

Comfort: Operating range down to -20 °C.

Control: Additional functions with optional PCB (2 zone control, bivalent control, Smart Grid contact and more).

Connectivity: Optional Aquarea Smart and Service Cloud and integration into BMS projects.



Kit		Three phase (power to indoor)			
		KIT-ADC09HE8	KIT-ADC12HE8	KIT-ADC16HE8	
Heating capacity / COP (A +7 °C, W 35 °C)	kW / COP	9,00/4,84	12,00/4,74	16,00/4,28	
Heating capacity / COP (A +7 °C, W 55 °C)	kW / COP	9,00/2,94	12,00/2,93	14,50/2,72	
Heating capacity / COP (A +2 °C, W 35 °C)	kW / COP	9,00/3,59	11,40/3,44	13,00/3,28	
Heating capacity / COP (A +2 °C, W 55 °C)	kW / COP	8,80/2,23	9,10/2,23	9,80/2,21	
Heating capacity / COP (A -7 °C, W 35 °C)	kW / COP	9,00/2,85	10,00/2,73	11,40/2,57	
Heating capacity / COP (A -7 °C, W 55 °C)	kW / COP	7,90/2,05	8,20/1,95	9,00/1,85	
Cooling capacity / EER (A 35 °C, W 7 °C)	kW / EER	7,00/3,17	10,00/2,85	12,20/2,56	
Cooling capacity / EER (A 35 °C, W 18 °C)	kW / EER	7,00/4,67	10,00/4,26	12,20/4,12	
Heating average climate (W 35 °C / W 55 °C)	Seasonal energy efficiency	SCOP (η _s %)	4,81/3,41(190/133)	4,82/3,42(190/134)	4,82/3,33(190/130)
	Energy class ¹⁾	A+++ to D	A+++/A++	A+++/A++	A+++/A++
Heating warm climate (W 35 °C / W 55 °C)	Seasonal energy efficiency	SCOP (η _s %)	6,21/4,05(245/159)	6,21/4,05(245/159)	6,20/4,30(245/169)
	Energy class ¹⁾	A+++ to D	A+++/A+++	A+++/A+++	A+++/A+++
Heating cold climate (W 35 °C / W 55 °C)	Seasonal energy efficiency	SCOP (η _s %)	4,28/3,10(168/121)	4,29/3,10(168/121)	4,28/3,10(168/121)
	Energy class ¹⁾	A+++ to D	A++/A+	A++/A+	A++/A+
Indoor unit		WH-ADC0916H9E8	WH-ADC0916H9E8	WH-ADC0916H9E8	
Sound pressure	Heat / Cool	dB(A)	33/33	33/33	
Dimension	HxWxD	mm	1800x598x717	1800x598x717	
Net weight		kg	126	126	
Water pipe connector		Inch	R 1¼	R 1¼	
A class pump	Number of speeds		Variable speed	Variable speed	
	Input power (Min/Max)	W	36/152	36/152	
Heating water flow (ΔT=5 K, 35 °C)		L/min	25,8	34,4	
Electric backup heater		kW	9,00	9,00	
Recommended fuse		A	16/16	16/16	
Recommended minimum cable size, supply 1 / 2 ²⁾		mm ²	5x1,5/5x1,5	5x1,5/5x1,5	
Water volume		L	185	185	
Maximum DHW temperature		°C	65	65	
Material inside tank			Stainless steel	Stainless steel	
Tapping profile according EN16147			L	L	
DHW tank ERP efficiency average / warm / cold ³⁾	A+ to F	A/A/A	A/A/A	A/A/B	
DHW tank ERP average climate η / COPdHW	η _{wh} % / COPdHW	95/2,37	95/2,37	91/2,27	
DHW tank ERP warm climate η / COPdHW	η _{wh} % / COPdHW	110/2,75	110/2,75	107/2,67	
DHW tank ERP cold climate η / COPdHW	η _{wh} % / COPdHW	75/1,87	75/1,87	72/1,80	
Outdoor unit		WH-UD09HE8	WH-UD12HE8	WH-UD16HE8	
Sound power ⁴⁾	Heat	dB(A)	65	65	
Dimension / Net weight	HxWxD	mm / kg	1340x900x320/107	1340x900x320/107	
Refrigerant (R410A) / CO ₂ Eq.		kg / T	2,55/5,324	2,55/5,324	
Piping diameter	Liquid / Gas	Inch (mm)	3/8(9,52)/5/8(15,88)	3/8(9,52)/5/8(15,88)	
Pipe length range / Elevation difference (in / out)		m / m	3-30/20	3-30/20	
Pre-charged pipe length / Additional gas amount		m / g/m	10/50	10/50	
Operating range - outdoor ambient	Heat	°C	-20 ~ +35	-20 ~ +35	
	Cool	°C	+16 ~ +43	+16 ~ +43	
Water outlet	Heat / Cool	°C	20 ~ 55/5 ~ 20	20 ~ 55/5 ~ 20	

1) Scale from A+++ to D. 2) Check local regulations. 3) Scale from A+ to F. 4) Sound power in accordance to 811/2013, 813/2013 and EN12102-1:2017 at +7 °C. * EER and COP calculation is based in accordance to EN14511. ** This product is designed to comply with the European drinking water standard (EU) 2020/2184. The lifespan of the product is not guaranteed in the case of the use of groundwater, such as spring water or well water, the use of tap water when salt or other impurities are contained, nor in areas of acidic water quality. Maintenance and warranty costs related to these cases are the customer's responsibility.

Accessories

CZ-TAW1B	Aquarea Smart Cloud for remote control and maintenance through wireless or wired LAN
CZ-TAW1-CBL	10 m extension cable for CZ-TAW1B

Accessories

CZ-NS4P	PCB for advanced functions
PAW-A2W-RTWIRED	Room thermostat
PAW-A2W-RTWIRELESS	Wireless LCD room thermostat



INTERNET CONTROL: Optional.

Aquarea High Performance Bi-bloc K Series Single phase. Heating and Cooling - SDC - R32

Energy efficiency: COP up to 5,33 / A+++ in heating at 35 °C / "A" water pump with variable speed / Built-in flow meter.

Flexibility: Long piping lengths / Built-in magnetic water filter.

Comfort: Operation without backup heating at -25 °C / 60 °C hot water even at -10 °C outside temperature.

Control: Optimised user interface and improved features [2 zone control, bivalent control].

Connectivity: Optional Aquarea Smart and Service Cloud and integration into BMS projects.



		Single phase (power to indoor)							
Kit 3 kW electric heater		KIT-WC03K3E5	KIT-WC05K3E5	KIT-WC07K3E5	KIT-WC09K3E5	—			
Kit 6 kW electric heater		KIT-WC03K6E5	KIT-WC05K6E5	KIT-WC07K6E5	KIT-WC09K6E5	KIT-WC12K6E5*			
Heating capacity / COP (A +7 °C, W 35 °C)	kW / COP	3,20/5,33	5,00/5,10	7,00/4,86	9,00/4,55	12,10/4,78			
Heating capacity / COP (A +7 °C, W 55 °C)	kW / COP	3,20/2,81	5,00/3,03	7,00/2,92	8,90/2,93	12,00/2,96			
Heating capacity / COP (A +2 °C, W 35 °C)	kW / COP	3,20/3,64	5,00/3,57	6,85/3,43	7,00/3,40	11,50/3,44			
Heating capacity / COP (A +2 °C, W 55 °C)	kW / COP	3,20/2,19	5,00/2,29	6,25/2,23	6,30/2,18	9,20/2,25			
Heating capacity / COP (A -7 °C, W 35 °C)	kW / COP	3,30/2,80	5,00/2,79	5,75/2,95	6,25/2,84	10,10/2,74			
Heating capacity / COP (A -7 °C, W 55 °C)	kW / COP	3,20/1,79	5,00/1,89	5,35/1,98	5,90/1,93	8,40/1,97			
Cooling capacity / EER (A 35 °C, W 7 °C)	kW / EER	3,20/3,52	5,00/3,05	6,70/3,03	8,20/2,72	10,70/2,68			
Cooling capacity / EER (A 35 °C, W 18 °C)	kW / EER	3,20/4,71	5,00/4,90	6,70/4,72	9,00/4,18	10,70/3,92			
Heating average climate (W 35 °C / W 55 °C)	Seasonal energy efficiency	SCOP (η _s %)	5,07/3,47(200/136)	5,12/3,63(202/142)	4,90/3,62(193/142)	4,44/3,41(175/133)	4,58/3,33(180/130)		
	Energy class ¹⁾		A+++ / A++	A+++ / A++	A+++ / A++	A+++ / A++	A+++ / A++		
Heating warm climate (W 35 °C / W 55 °C)	Seasonal energy efficiency	SCOP (η _s %)	6,20/4,20(245/165)	6,00/4,20(237/165)	5,75/4,07(227/160)	5,75/4,07(227/160)	6,47/4,34(256/171)		
	Energy class ¹⁾		A+++ / A+++	A+++ / A+++	A+++ / A+++	A+++ / A+++	A+++ / A+++		
Heating cold climate (W 35 °C / W 55 °C)	Seasonal energy efficiency	SCOP (η _s %)	4,00/2,83(157/110)	4,08/2,95(160/115)	4,18/2,98(164/116)	4,18/2,98(164/116)	4,31/3,26(169/127)		
	Energy class ¹⁾		A++ / A+	A++ / A+	A++ / A+	A++ / A+	A++ / A++		
Indoor unit 3 kW electric heater		WH-SDC0309K3E5	WH-SDC0309K3E5	WH-SDC0309K3E5	WH-SDC0309K3E5	—			
Indoor unit 6 kW electric heater		WH-SDC0309K6E5	WH-SDC0309K6E5	WH-SDC0309K6E5	WH-SDC0309K6E5	WH-SDC12K6E5			
Sound pressure	Heat / Cool	dB(A)		28/28	30/30	30/31	33/33		
Dimension	H x W x D	mm		892 x 500 x 348	892 x 500 x 348	892 x 500 x 348	892 x 500 x 348		
Net weight 3 kW / 6 kW		kg		40/41	40/41	40/41	41		
Water pipe connector		Inch		R 1¼	R 1¼	R 1¼	R 1¼		
A class pump	Number of speeds	Variable speed		Variable speed	Variable speed	Variable speed	Variable speed		
	Input power	W		145	145	145	145		
Heating water flow (ΔT=5 K, 35 °C)		L/min		9,2	14,3	20,1	25,8		
Outdoor unit		WH-UDZ03KE5	WH-UDZ05KE5	WH-UDZ07KE5	WH-UDZ09KE5	WH-UDZ12KE5			
Sound power ²⁾	Heat	dB(A)		55	55	56	56		
Dimension	H x W x D	mm		622 x 824 x 298	795 x 875 x 380	795 x 875 x 380	795 x 875 x 380		
Net weight		kg		37	55	55	88		
Refrigerant (R32) / CO ₂ Eq.		kg / T		0,9/0,608	1,3/0,878	1,3/0,878	1,3/0,878		
Piping diameter	Liquid / Gas	Inch (mm)		1/4(6,35)/1/2(12,70)	1/4(6,35)/5/8(15,88)	1/4(6,35)/5/8(15,88)	1/4(6,35)/5/8(15,88)		
Pipe length range		m		3 - 25	3 - 40 [3 - 50] ³⁾	3 - 40 [3 - 50] ³⁾	3 - 40 [3 - 50] ³⁾		
Elevation difference (in / out)		m		20	30	30	20		
Pre-charged pipe length		m		10	10	10	10		
Additional gas amount		g/m		20	25	25	30		
Operating range - outdoor ambient	Heat	°C		-20 ~ +35	-25 ~ +35	-25 ~ +35	-25 ~ +35		
	Cool	°C		+10 ~ +43	+10 ~ +43	+10 ~ +43	+10 ~ +43		
Water outlet ⁴⁾	Heat / Cool	°C		20 ~ 60/5 ~ 20	20 ~ 60/5 ~ 20	20 ~ 60/5 ~ 20	20 ~ 60/5 ~ 20		
Electrical information		Heater	3 kW	6 kW	3 kW	6 kW	3 kW	6 kW	6 kW
Electric backup heater		kW	3,00	6,00	3,00	6,00	3,00	6,00	6,00
Recommended fuse		A	16/16	16/30	16/16	16/30	25/16	25/30	30/30
Recommended minimum cable size, supply 1 / 2 ⁵⁾		mm ²	3x1,5/ 3x1,5	3x1,5/ 3x4,0	3x1,5/ 3x1,5	3x1,5/ 3x4,0	3x2,5/ 3x4,0	3x2,5/ 3x4,0	3x4,0/3x4,0

1) Scale from A+++ to D. 2) Sound power level in accordance to EN12102 under conditions of the EN14825. 3) Operation range down to -25 °C in heating with 3 - 40 m pipe length range, operation range down to -15 °C in heating with 3 - 50 m pipe length range. 4) Between outdoor ambient -10 °C and -15 °C, the water outlet temperature gradually decreases from 60 °C to 55 °C. 5) Check local regulations. * Available in Summer 2024. Tentative data. ** EER and COP classification is at 230 V only in accordance with EU directive 2003/32/EC. *** This product is designed to comply with the European drinking water standard (EU) 2020/2184. The lifespan of the product is not guaranteed in the case of the use of groundwater, such as spring water or well water, the use of tap water when salt or other impurities are contained, nor in areas of acidic water quality. Maintenance and warranty costs related to these cases are the customer's responsibility.

Accessories	
CZ-RTW1	Optional remote controller for 2 zone control. K and L Series
PAW-TD20C1E5-1	Tank 200 L - Stainless steel
PAW-TD30C1E5-1	Tank 300 L - Stainless steel
PAW-TA20C1E5STD	Tank 200 L - Enamelled
PAW-TA30C1E5STD	Tank 300 L - Enamelled
PAW-3WYVLV-HW	3 way valve for DHW tanks
CZ-NV2	3 way valve kit to fit inside the hydrokit. K and L Series

Accessories	
PAW-BTANK50L-2	Buffer tank 50 L
CZ-TAW1B	Aquarea Smart Cloud for remote control and maintenance through wireless or wired LAN
CZ-TAW1-CBL	10 m extension cable for CZ-TAW1B
CZ-NS5P	PCB for advanced functions
PAW-A2W-RTWIRED	Room thermostat
PAW-A2W-RTWIRELESS	Wireless LCD room thermostat



INTERNET CONTROL: Optional.

NEW Aquarea High Performance Bi-bloc K Series Three phase. Heating and Cooling - SDC - R32

Energy efficiency: A+++ in heating at 35 °C / "A" water pump with variable speed / Built-in flow meter.

Flexibility: Long piping lengths / Built-in magnetic water filter.

Comfort: Operation without backup heating at -25 °C / 60 °C hot water even at -10 °C outside temperature.

Control: Optimised user interface and improved features (2 zone control, bivalent control).

Connectivity: Optional Aquarea Smart and Service Cloud and integration into BMS projects.



				Three phase (power to indoor)							
Kit 3 kW electric heater		KIT-WC09K3E8*		—		—					
Kit 9 kW electric heater		KIT-WC09K9E8*		KIT-WC12K9E8*		KIT-WC16K9E8*					
Heating capacity / COP (A +7 °C, W 35 °C)		kW / COP		9,00 / 4,90		12,10 / 4,78		16,00 / 4,31			
Heating capacity / COP (A +7 °C, W 55 °C)		kW / COP		9,00 / 2,97		12,00 / 2,96		14,70 / 2,72			
Heating capacity / COP (A +2 °C, W 35 °C)		kW / COP		9,00 / 3,63		11,50 / 3,44		13,20 / 3,28			
Heating capacity / COP (A +2 °C, W 55 °C)		kW / COP		9,00 / 2,26		9,20 / 2,25		10,00 / 2,21			
Heating capacity / COP (A -7 °C, W 35 °C)		kW / COP		9,00 / 2,88		10,10 / 2,74		11,60 / 2,57			
Heating capacity / COP (A -7 °C, W 55 °C)		kW / COP		8,10 / 2,07		8,40 / 1,97		9,10 / 1,85			
Cooling capacity / EER (A 35 °C, W 7 °C)		kW / EER		8,80 / 3,11		10,70 / 2,68		13,40 / 2,64			
Cooling capacity / EER (A 35 °C, W 18 °C)		kW / EER		8,80 / 4,63		10,70 / 3,92		15,50 / 3,60			
Heating average climate (W 35 °C / W 55 °C)		Seasonal energy efficiency		SCOP (η _s %)		4,96 / 3,57 (195 / 140)		4,58 / 3,33 (180 / 130)		4,46 / 3,40 (176 / 133)	
		Energy class ¹⁾		A+++ to D		A+++ / A++		A+++ / A++		A+++ / A++	
Heating warm climate (W 35 °C / W 55 °C)		Seasonal energy efficiency		SCOP (η _s %)		6,47 / 4,34 (256 / 171)		6,47 / 4,34 (256 / 171)		6,20 / 4,30 (245 / 169)	
		Energy class ¹⁾		A+++ to D		A+++ / A+++		A+++ / A+++		A+++ / A+++	
Heating cold climate (W 35 °C / W 55 °C)		Seasonal energy efficiency		SCOP (η _s %)		4,31 / 3,26 (169 / 127)		4,31 / 3,26 (169 / 127)		4,28 / 3,10 (168 / 121)	
		Energy class ¹⁾		A+++ to D		A++ / A++		A++ / A++		A++ / A+	
Indoor unit 3 kW electric heater		WH-SDC09K3E8		—		—		—		—	
Indoor unit 9 kW electric heater		WH-SDC09K9E8		WH-SDC12K9E8		WH-SDC16K9E8		WH-SDC16K9E8		WH-SDC16K9E8	
Sound pressure		Heat / Cool		dB(A)		33 / 33		33 / 33		33 / 33	
Dimension		H x W x D		mm		892 x 500 x 348		892 x 500 x 348		892 x 500 x 348	
Net weight 3 kW / 9 kW		kg		40 / 41		— / 41		— / 41		— / 41	
Water pipe connector		Inch		R 1¼		R 1¼		R 1¼		R 1¼	
A class pump		Number of speeds		Variable speed		Variable speed		Variable speed		Variable speed	
		Input power		W		145		145		145	
Heating water flow (ΔT=5 K, 35 °C)		L/min		25,8		34,4		45,9		45,9	
Outdoor unit		WH-UDZ09KE8		WH-UDZ12KE8		WH-UDZ16KE8		WH-UDZ16KE8		WH-UDZ16KE8	
Sound power ²⁾		Heat		dB(A)		65		65		65	
Dimension		H x W x D		mm		1340 x 900 x 320		1340 x 900 x 320		1340 x 900 x 320	
Net weight		kg		90		90		103		103	
Refrigerant (R32) / CO ₂ Eq.		kg / T		1,60 / 1,080		1,60 / 1,080		1,83 / 1,235		1,83 / 1,235	
Piping diameter		Liquid / Gas		Inch (mm)		1/4 (6,35) / 1/2 (12,70)		1/4 (6,35) / 1/2 (12,70)		1/4 (6,35) / 1/2 (12,70)	
Pipe length range		m		3 - 30		3 - 30		3 - 30		3 - 30	
Elevation difference (in / out)		m		20		20		20		20	
Pre-charged pipe length		m		10		10		10		10	
Additional gas amount		g/m		30		30		30		30	
Operating range - outdoor ambient		Heat		°C		-25 ~ +35		-25 ~ +35		-25 ~ +35	
		Cool		°C		+10 ~ +43		+10 ~ +43		+10 ~ +43	
Water outlet ³⁾		Heat / Cool		°C		20 ~ 60 / 5 ~ 20		20 ~ 60 / 5 ~ 20		20 ~ 60 / 5 ~ 20	
Electrical information		3 kW heater		9 kW heater		9 kW heater		9 kW heater		9 kW heater	
Electric backup heater		kW		3,00		9,00		9,00		9,00	
Recommended fuse		A		20 / 15 / 16		20 / 20		20 / 20		20 / 20	
Recommended minimum cable size, supply 1 / 2 ⁴⁾		mm ²		5x1,5 / 3x1,5		5x1,5 / 5x1,5		5x1,5 / 5x1,5		5x2,5 / 5x1,5	

1) Scale from A+++ to D. 2) Sound power level in accordance to EN12102 under conditions of the EN14825. 3) Operation range down to -25 °C in heating with 3 - 40 m pipe length range, operation range down to -15 °C in heating with 3 - 50 m pipe length range. 4) Between outdoor ambient -10 °C and -15 °C, the water outlet temperature gradually decreases from 60 °C to 55 °C. 5) Check local regulations. * Available in Summer 2024. Tentative data. ** EER and COP classification is at 230 V only in accordance with EU directive 2003/32/EC. *** This product is designed to comply with the European drinking water standard (EU) 2020/2184. The lifespan of the product is not guaranteed in the case of the use of groundwater, such as spring water or well water, the use of tap water when salt or other impurities are contained, nor in areas of acidic water quality. Maintenance and warranty costs related to these cases are the customer's responsibility.

Accessories	
CZ-RTW1	Optional remote controller for 2 zone control. K and L Series
PAW-TD20C1E5-1	Tank 200 L - Stainless steel
PAW-TD30C1E5-1	Tank 300 L - Stainless steel
PAW-TA20C1E5STD	Tank 200 L - Enamelled
PAW-TA30C1E5STD	Tank 300 L - Enamelled
PAW-3WYVLV-HW	3 way valve for DHW tanks
CZ-NV2	3 way valve kit to fit inside the hydrokit. K and L Series

Accessories	
PAW-BTANK50L-2	Buffer tank 50 L
CZ-TAW1B	Aquarea Smart Cloud for remote control and maintenance through wireless or wired LAN
CZ-TAW1-CBL	10 m extension cable for CZ-TAW1B
CZ-NS5P	PCB for advanced functions
PAW-A2W-RTWIRED	Room thermostat
PAW-A2W-RTWIREDLESS	Wireless LCD room thermostat



INTERNET CONTROL: Optional.

Aquarea High Performance Bi-bloc H Series Single phase / Three phase. Heating and Cooling - SDC · R410A

Energy efficiency: A+++ in heating at 35 °C / "A" water pump with variable speed / Built-in flow meter.

Flexibility: Optional magnet for the water filter.

Comfort: Operating range down to -20 °C.

Control: Additional functions with optional PCB (2 zone control, bivalent control, Smart Grid contact and more).

Connectivity: Optional Aquarea Smart and Service Cloud and integration into BMS projects.

011-1W0515

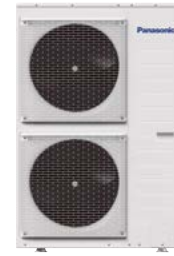

Kit	Single phase			Three phase (power to indoor)			
	KIT-WC12H6E5	KIT-WC16H6E5	KIT-WC09H3E8	KIT-WC12H9E8	KIT-WC16H9E8		
Heating capacity / COP (A +7 °C, W 35 °C)	kW / COP		12,00/4,74	16,00/4,28	9,00/4,84	12,00/4,74	16,00/4,28
Heating capacity / COP (A +7 °C, W 55 °C)	kW / COP		12,00/2,88	14,50/2,68	9,00/2,94	12,00/2,88	14,50/2,68
Heating capacity / COP (A +2 °C, W 35 °C)	kW / COP		11,40/3,44	13,00/3,28	9,00/3,59	11,40/3,44	13,00/3,28
Heating capacity / COP (A +2 °C, W 55 °C)	kW / COP		9,10/2,20	9,80/2,17	8,80/2,23	9,10/2,20	9,80/2,17
Heating capacity / COP (A -7 °C, W 35 °C)	kW / COP		10,00/2,73	11,40/2,57	9,00/2,85	10,00/2,73	11,40/2,57
Heating capacity / COP (A -7 °C, W 55 °C)	kW / COP		8,20/1,92	9,00/1,82	7,90/2,05	8,20/1,92	9,00/1,82
Cooling capacity / EER (A 35 °C, W 7 °C)	kW / EER		10,00/2,81	12,20/2,56	7,00/3,14	10,00/3,91	12,20/2,56
Cooling capacity / EER (A 35 °C, W 18 °C)	kW / EER		10,00/4,17	12,20/4,12	7,00/4,61	10,00/4,17	12,20/4,12
Heating average climate (W 35 °C / W 55 °C)	Seasonal energy efficiency	SCOP (η _s %)	4,82/3,42(190/134)	4,82/3,33(190/130)	4,81/3,41(190/133)	4,82/3,42(190/134)	4,82/3,33(190/130)
	Energy class		A+++ / A++	A+++ / A++	A+++ / A++	A+++ / A++	A+++ / A++
Heating warm climate (W 35 °C / W 55 °C)	Seasonal energy efficiency	SCOP (η _s %)	6,21/4,05(245/159)	6,21/4,30(245/169)	6,21/4,05(245/159)	6,21/4,05(245/159)	6,20/4,30(245/169)
	Energy class		A+++ / A+++	A+++ / A+++	A+++ / A+++	A+++ / A+++	A+++ / A+++
Heating cold climate (W 35 °C / W 55 °C)	Seasonal energy efficiency	SCOP (η _s %)	4,29/3,10(168/121)	4,28/3,10(168/121)	4,28/3,10(168/121)	4,29/3,10(168/121)	4,28/3,10(168/121)
	Energy class		A++ / A+	A++ / A+	A++ / A+	A++ / A+	A++ / A+
Indoor unit			WH-SDC12H6E5	WH-SDC16H6E5	WH-SDC09H3E8	WH-SDC12H9E8	WH-SDC16H9E8
Sound pressure	Heat / Cool	dB(A)	33/33	33/33	33/33	33/33	33/33
Dimension	HxWxD	mm	892x500x340	892x500x340	892x500x340	892x500x340	892x500x340
Net weight		kg	43	44	43	44	45
Water pipe connector		Inch	R 1½	R 1½	R 1½	R 1½	R 1½
A class pump	Number of speeds		Variable speed	Variable speed	Variable speed	Variable speed	Variable speed
	Input power (Min/Max)	W	34/110	30/105	32/102	34/110	30/105
Heating water flow (ΔT=5 K, 35 °C)		L/min	34,4	45,9	25,8	34,4	45,9
Electric backup heater		kW	6,00	6,00	3,00	9,00	9,00
Recommended fuse		A	30/30	30/30	15/30	15/30	15/30
Recommended minimum cable size, supply 1 / 2 ¹⁾		mm ²	3x4,0 ou 6,0/3x4,0	3x4,0 ou 6,0/3x4,0	5x1,5/5x1,5	5x1,5/5x1,5	5x1,5/5x1,5
Outdoor unit			WH-UD12HE5	WH-UD16HE5	WH-UD09HE8	WH-UD12HE8	WH-UD16HE8
Sound power ²⁾	Heat	dB(A)	65	65	65	65	65
Dimension	HxWxD	mm	1340x900x320	1340x900x320	1340x900x320	1340x900x320	1340x900x320
Net weight		kg	101	101	107	107	107
Refrigerant (R410A) / CO ₂ Eq.		kg / T	2,55/5,324	2,55/5,324	2,55/5,324	2,55/5,324	2,55/5,324
Piping diameter	Liquid / Gas	Inch (mm)	3/8(9,52)/5/8(15,88)	3/8(9,52)/5/8(15,88)	3/8(9,52)/5/8(15,88)	3/8(9,52)/5/8(15,88)	3/8(9,52)/5/8(15,88)
Pipe length range		m	3-50	3-50	3-30	3-30	3-30
Elevation difference (in / out)		m	30	30	20	20	20
Pre-charged pipe length		m	10	10	10	10	10
Additional gas amount		g/m	50	50	50	50	50
Operating range - outdoor ambient	Heat	°C	-20 ~ +35	-20 ~ +35	-20 ~ +35	-20 ~ +35	-20 ~ +35
	Cool	°C	+16 ~ +43	+16 ~ +43	+16 ~ +43	+16 ~ +43	+16 ~ +43
Water outlet	Heat / Cool	°C	20-55/5-20	20-55/5-20	20-55/5-20	20-55/5-20	20-55/5-20

1) Check local regulations. 2) Sound power in accordance to 811/2013, 813/2013 and EN12102-1:2017 at +7 °C. * EER and COP calculation is based in accordance to EN14511.

Accessories	
PAW-TD20C1E5-1	Tank 200 L - Stainless steel
PAW-TD30C1E5-1	Tank 300 L - Stainless steel
PAW-TA20C1E5STD	Tank 200 L - Enamelled
PAW-TA30C1E5STD	Tank 300 L - Enamelled
PAW-3WYVLV-HW	3 way valve for DHW tanks
CZ-NV1	3 way valve kit to fit inside the hydrokit. J and H Series
PAW-BTANK50L-2	Buffer tank 50 L

Accessories	
CZ-TAW1B	Aquarea Smart Cloud for remote control and maintenance through wireless or wired LAN
CZ-TAW1-CBL	10 m extension cable for CZ-TAW1B
CZ-NS4P	PCB for advanced functions
PAW-A2W-MGTFILTER	Magnet for the water filter
PAW-A2W-RTWIRED	Room thermostat
PAW-A2W-RTWIRELESS	Wireless LCD room thermostat



INTERNET CONTROL: Optional.

Aquarea T-CAP All in One K Series Single phase / Three phase. Heating and Cooling - R32

Energy efficiency: A+++ in heating at 35 °C and A+ in DHW / "A" water pump with variable speed / Stainless steel DHW tank with U-Vacua™ insulation panel / Built-in flow meter.

Flexibility: 598 x 600 footprint / Built-in magnetic water filter.

Comfort: Constant capacity down to -20 °C / Operating range down to -28 °C / 60 °C hot water even at -10 °C outside temperature.

Control: Optimised user interface and improved features (2 zone control, bivalent control).

Connectivity: Optional Aquarea Smart and Service Cloud and integration into BMS projects.



Kit	Single phase (power to indoor)					Three phase (power to indoor)					
		KIT-AXC09K6E5	KIT-AXC12K6E5	KIT-AXC09K9E8*	KIT-AXC12K9E8*	KIT-AXC16K9E8*					
Heating capacity / COP (A +7 °C, W 35 °C)	kW / COP	9,00/5,03	12,10/4,84	9,00/5,03	12,10/4,84	16,00/4,38					
Heating capacity / COP (A +7 °C, W 55 °C)	kW / COP	9,00/3,07	12,10/3,04	9,00/3,07	12,10/3,04	16,00/2,72					
Heating capacity / COP (A +2 °C, W 35 °C)	kW / COP	9,00/3,69	12,00/3,44	9,00/3,69	12,00/3,44	16,00/3,10					
Heating capacity / COP (A +2 °C, W 55 °C)	kW / COP	9,00/2,31	12,00/2,29	9,00/2,31	12,00/2,29	16,00/2,07					
Heating capacity / COP (A -7 °C, W 35 °C)	kW / COP	9,00/3,00	12,00/2,72	9,00/3,00	12,00/2,72	16,00/2,39					
Heating capacity / COP (A -7 °C, W 55 °C)	kW / COP	9,00/2,10	12,00/2,29	9,00/2,10	12,00/2,29	16,00/1,71					
Cooling capacity / EER (A 35 °C, W 7 °C)	kW / EER	8,80/3,11	10,70/2,68	8,80/3,11	10,70/2,68	13,40/2,64					
Cooling capacity / EER (A 35 °C, W 18 °C)	kW / EER	8,80/4,63	10,70/3,92	8,80/4,63	10,70/3,92	13,40/2,64					
Heating average climate (W 35 °C / W 55 °C)	Seasonal energy efficiency	SCOP (η _s %)	4,96/3,57(195/140)	4,96/3,57(195/140)	4,96/3,57(195/140)	4,58/3,46(180/135)	4,46/3,31(176/129)				
	Energy class ¹⁾	A+++ to D	A+++/A++	A+++/A++	A+++/A++	A+++/A++	A+++/A++				
Heating warm climate (W 35 °C / W 55 °C)	Seasonal energy efficiency	SCOP (η _s %)	6,47/4,34(256/171)	6,47/4,34(256/171)	6,47/4,34(256/171)	6,47/4,34(256/171)	5,88/4,09(232/160)				
	Energy class ¹⁾	A+++ to D	A+++/A+++	A+++/A+++	A+++/A+++	A+++/A+++	A+++/A+++				
Heating cold climate (W 35 °C / W 55 °C)	Seasonal energy efficiency	SCOP (η _s %)	4,31/3,26(169/127)	4,31/3,26(169/127)	4,31/3,26(169/127)	4,31/3,26(169/127)	3,83/3,20(155/125)				
	Energy class ¹⁾	A+++ to D	A++/A++	A++/A++	A++/A++	A++/A++	A++/A++				
Indoor unit			WH-ADC0912K6E5	WH-ADC0912K6E5	WH-ADC0912K9E8	WH-ADC0912K9E8	WH-ADC16K9E8				
Sound pressure	Heat / Cool	dB(A)	33/33	33/33	33/33	33/33	33/33				
Dimension	HxWxD	mm	1642x599x602	1642x599x602	1642x599x602	1642x599x602	1642x599x602				
Net weight		kg	101	101	102	102	103				
Water pipe connector		Inch	R 1½	R 1½	R 1½	R 1½	R 1½				
A class pump	Number of speeds		Variable speed	Variable speed	Variable speed	Variable speed	Variable speed				
	Input power	W	145	145	145	145	173				
Heating water flow (ΔT=5 K, 35 °C)		L/min	25,8	34,4	25,8	34,4	45,9				
Water volume		L	185	185	185	185	185				
Maximum DHW temperature		°C	65	65	65	65	65				
Material inside tank			Stainless steel	Stainless steel	Stainless steel	Stainless steel	Stainless steel				
Tapping profile according EN16147			L	L	L	L	L				
DHW tank ERP efficiency average / warm / cold ²⁾		A+ to F	A/A+/A	A/A+/A	A/A+/A	A/A+/A	A/A+/A				
DHW tank ERP average climate η / COPdHW	η _{wh} % / COPdHW		112/2,80	112/2,80	112/2,80	112/2,80	107/2,68				
DHW tank ERP warm climate η / COPdHW	η _{wh} % / COPdHW		132/3,30	132/3,30	132/3,30	132/3,30	128/3,20				
DHW tank ERP cold climate η / COPdHW	η _{wh} % / COPdHW		88/2,20	88/2,20	88/2,20	88/2,20	84/2,10				
Outdoor unit			WH-UXZ09KE5	WH-UXZ12KE5	WH-UXZ09KE8	WH-UXZ12KE8	WH-UXZ16KE8				
Sound power ³⁾	Heat	dB(A)	65	65	65	65	65				
Dimension / Net weight	HxWxD	mm / kg	1340x900x320/88	1340x900x320/88	1340x900x320/90	1340x900x320/90	1340x900x320/103				
Refrigerant (R32) / CO ₂ Eq.		kg / T	1,60/1,080	1,60/1,080	1,60/1,080	1,60/1,080	1,83/1,235				
Piping diameter	Liquid / Gas	Inch (mm)	1/4(6,35)/1/2(12,70)	1/4(6,35)/1/2(12,70)	1/4(6,35)/1/2(12,70)	1/4(6,35)/1/2(12,70)	1/4(6,35)/1/2(12,70)				
Pipe length range / Elevation difference (in / out)		m / m	3-30/20	3-30/20	3-30/20	3-30/20	3-30/20				
Pre-charged pipe length / Additional gas amount		m / g/m	10/30	10/30	10/30	10/30	10/30				
Operating range - outdoor ambient	Heat	°C	-28 ~ +35	-28 ~ +35	-28 ~ +35	-28 ~ +35	-28 ~ +35				
	Cool	°C	+10 ~ +43	+10 ~ +43	+10 ~ +43	+10 ~ +43	+10 ~ +43				
Water outlet ⁴⁾	Heat / Cool	°C	20 ~ 60/5 ~ 20	20 ~ 60/5 ~ 20	20 ~ 60/5 ~ 20	20 ~ 60/5 ~ 20	20 ~ 60/5 ~ 20				
Electrical information			WH-ADC0912K6E5	WH-ADC0912K6E5	WH-ADC0912K9E8	WH-ADC0912K9E8	WH-ADC16K9E8				
Electric backup heater		kW	6,00	6,00	9,00	9,00	9,00				
Recommended fuse		A	30/30	30/30	20/20	20/20	20/20				
Recommended minimum cable size, supply 1 / 2 ⁵⁾		mm ²	3x4,0/3x4,0	3x4,0/3x4,0	5x1,5/5x1,5	5x1,5/5x1,5	5x2,5/5x1,5				

1) Scale from A+++ to D. 2) Scale from A+ to F. 3) Sound power level in accordance to EN12102 under conditions of the EN14825. 4) Between outdoor ambient -10 °C and -15 °C, the water outlet temperature gradually decreases from 60 °C to 55 °C. 5) Check local regulations. * Available in Summer 2024. ** EER and COP classification is at 230 V only in accordance with EU directive 2003/32/EC. *** This product is designed to comply with the European drinking water standard (EU) 2020/2184. The lifespan of the product is not guaranteed in the case of the use of groundwater, such as spring water or well water, the use of tap water when salt or other impurities are contained, nor in areas of acidic water quality. Maintenance and warranty costs related to these cases are the customer's responsibility.

Accessories

CZ-RTW1	Optional remote controller for 2 zone control. K and L Series
CZ-TAW1B	Aquarea Smart Cloud for remote control and maintenance through wireless or wired LAN

Accessories

CZ-TAW1-CBL	10 m extension cable for CZ-TAW1B
CZ-NS5P	PCB for advanced functions
PAW-A2W-RTWIRED	Room thermostat
PAW-A2W-RTWIRELESS	Wireless LCD room thermostat



INTERNET CONTROL: Optional.

Aquarea T-CAP All in One K Series Single phase / Three phase. Heating and Cooling with Electrical Anode - R32

Energy efficiency: A+++ in heating at 35 °C and A+ in DHW / "A" water pump with variable speed / Stainless steel DHW tank with U-Vacua™ insulation panel / Built-in flow meter.

Flexibility: 598 x 600 footprint / Built-in magnetic water filter.

Comfort: Constant capacity down to -20 °C / Operating range down to -28 °C / 60 °C hot water even at -10 °C outside temperature.

Control: Optimised user interface and improved features [2 zone control, bivalent control].

Connectivity: Optional Aquarea Smart and Service Cloud and integration into BMS projects.

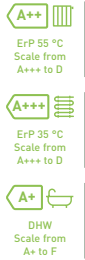

Kit	Single phase (power to indoor)			Three phase (power to indoor)			
	KIT-AXC09K6E5AN	KIT-AXC12K6E5AN	KIT-AXC09K9E8AN	KIT-AXC12K9E8AN	KIT-AXC16K9E8AN		
Heating capacity / COP (A +7 °C, W 35 °C)	kW / COP	9,00/5,03	12,10/4,84	9,00/5,03	12,10/4,84	16,00/4,38	
Heating capacity / COP (A +7 °C, W 55 °C)	kW / COP	9,00/3,07	12,10/3,04	9,00/3,07	12,10/3,04	16,00/2,72	
Heating capacity / COP (A +2 °C, W 35 °C)	kW / COP	9,00/3,69	12,00/3,44	9,00/3,69	12,00/3,44	16,00/3,10	
Heating capacity / COP (A +2 °C, W 55 °C)	kW / COP	9,00/2,31	12,00/2,29	9,00/2,31	12,00/2,29	16,00/2,07	
Heating capacity / COP (A -7 °C, W 35 °C)	kW / COP	9,00/3,00	12,00/2,72	9,00/3,00	12,00/2,72	16,00/2,39	
Heating capacity / COP (A -7 °C, W 55 °C)	kW / COP	9,00/2,10	12,00/2,29	9,00/2,10	12,00/2,29	16,00/1,71	
Cooling capacity / EER (A 35 °C, W 7 °C)	kW / EER	8,80/3,11	10,70/2,68	8,80/3,11	10,70/2,68	13,40/2,64	
Cooling capacity / EER (A 35 °C, W 18 °C)	kW / EER	8,80/4,63	10,70/3,92	8,80/4,63	10,70/3,92	13,40/2,64	
Heating average climate (W 35 °C / W 55 °C)	Seasonal energy efficiency	SCOP (η _s %)	4,96/3,57(195/140)	4,96/3,57(195/140)	4,96/3,57(195/140)	4,58/3,46(180/135)	4,46/3,31(176/129)
	Energy class ¹⁾		A+++ to D	A+++/A++	A+++/A++	A+++/A++	A+++/A++
Heating warm climate (W 35 °C / W 55 °C)	Seasonal energy efficiency	SCOP (η _s %)	6,47/4,34(256/171)	6,47/4,34(256/171)	6,47/4,34(256/171)	6,47/4,34(256/171)	5,88/4,09(232/160)
	Energy class ¹⁾		A+++ to D	A+++/A+++	A+++/A+++	A+++/A+++	A+++/A+++
Heating cold climate (W 35 °C / W 55 °C)	Seasonal energy efficiency	SCOP (η _s %)	4,31/3,26(169/127)	4,31/3,26(169/127)	4,31/3,26(169/127)	4,31/3,26(169/127)	3,83/3,20(150/125)
	Energy class ¹⁾		A+++ to D	A++/A++	A++/A++	A++/A++	A++/A++
Indoor unit		WH-	ADC0912K6E5AN	ADC0912K6E5AN	ADC0912K9E8AN	ADC0912K9E8AN	ADC16K9E8AN
Sound pressure	Heat / Cool	dB(A)	33/33	33/33	33/33	33/33	33/33
Dimension	HxWxD	mm	1642x599x602	1642x599x602	1642x599x602	1642x599x602	1642x599x602
Net weight		kg	101	101	102	102	103
Water pipe connector		Inch	R 1½	R 1½	R 1½	R 1½	R 1½
A class pump	Number of speeds		Variable speed	Variable speed	Variable speed	Variable speed	Variable speed
	Input power	W	145	145	145	145	173
Heating water flow (ΔT=5 K, 35 °C)		L/min	25,8	34,4	25,8	34,4	45,9
Water volume		L	185	185	185	185	185
Maximum DHW temperature		°C	65	65	65	65	65
Material inside tank			Stainless steel	Stainless steel	Stainless steel	Stainless steel	Stainless steel
Tapping profile according EN16147			L	L	L	L	L
DHW tank ERP efficiency average / warm / cold ²⁾		A+ to F	A/A+/A	A/A+/A	A/A+/A	A/A+/A	A/A+/A
DHW tank ERP average climate η / COPdHW	η _{wh} % / COPdHW		112/2,80	112/2,80	112/2,80	112/2,80	107/2,68
DHW tank ERP warm climate η / COPdHW	η _{wh} % / COPdHW		132/3,30	132/3,30	132/3,30	132/3,30	128/3,20
DHW tank ERP cold climate η / COPdHW	η _{wh} % / COPdHW		88/2,20	88/2,20	88/2,20	88/2,20	84/2,10
Outdoor unit			WH-UXZ09KE5	WH-UXZ12KE5	WH-UXZ09KE8	WH-UXZ12KE8	WH-UXZ16KE8
Sound power ³⁾	Heat	dB(A)	65	65	65	65	65
Dimension / Net weight	HxWxD	mm / kg	1340x900x320/88	1340x900x320/88	1340x900x320/90	1340x900x320/90	1340x900x320/103
Refrigerant (R32) / CO ₂ Eq.		kg / T	1,60/1,080	1,60/1,080	1,60/1,080	1,60/1,080	1,83/1,235
Piping diameter	Liquid / Gas	Inch (mm)	1/4(6,35)/1/2(12,70)	1/4(6,35)/1/2(12,70)	1/4(6,35)/1/2(12,70)	1/4(6,35)/1/2(12,70)	1/4(6,35)/1/2(12,70)
Pipe length range / Elevation difference (in / out)		m / m	3~30/20	3~30/20	3~30/20	3~30/20	3~30/20
Pre-charged pipe length / Additional gas amount		m / g/m	10/30	10/30	10/30	10/30	10/30
Operating range - outdoor ambient	Heat	°C	-28~+35	-28~+35	-28~+35	-28~+35	-28~+35
	Cool	°C	+10~+43	+10~+43	+10~+43	+10~+43	+10~+43
Water outlet	Heat / Cool	°C	20~60/5~20	20~60/5~20	20~60/5~20	20~60/5~20	20~60/5~20
Electrical information			WH-ADC0912K6E5AN	WH-ADC0912K6E5AN	WH-ADC0912K9E8AN	WH-ADC0912K9E8AN	WH-ADC16K9E8AN
Electric backup heater		kW	6,00	6,00	9,00	9,00	9,00
Recommended fuse		A	30/30	30/30	20/20	20/20	20/20
Recommended minimum cable size, supply 1 / 2 ⁴⁾		mm ²	3x4,0/3x4,0	3x4,0/3x4,0	5x1,5/5x1,5	5x1,5/5x1,5	5x2,5/5x1,5

1) Scale from A+++ to D. 2) Scale from A+ to F. 3) Sound power level in accordance to EN12102 under conditions of the EN14825. 4) Between outdoor ambient -10 °C and -15 °C, the water outlet temperature gradually decreases from 60 °C to 55 °C. 5) Check local regulations. * Available in Summer 2024. ** EER and COP classification is at 230 V only in accordance with EU directive 2003/32/EC. *** This product is designed to comply with the European drinking water standard (EU) 2020/2184. The lifespan of the product is not guaranteed in the case of the use of groundwater, such as spring water or well water, the use of tap water when salt or other impurities are contained, nor in areas of acidic water quality. Maintenance and warranty costs related to these cases are the customer's responsibility.

Accessories	
CZ-RTW1	Optional remote controller for 2 zone control. K and L Series
CZ-TAW1B	Aquarea Smart Cloud for remote control and maintenance through wireless or wired LAN

Accessories	
CZ-TAW1-CBL	10 m extension cable for CZ-TAW1B
CZ-NS5P	PCB for advanced functions
PAW-A2W-RTWIRED	Room thermostat
PAW-A2W-RTWIRESLESS	Wireless LCD room thermostat



INTERNET CONTROL: Optional.

Aquarea T-CAP All in One H Series Three phase. Heating and Cooling · R410A

Energy efficiency: A+++ in heating at 35 °C and A+ in DHW / "A" water pump with variable speed / Stainless steel DHW tank with U-Vacua™ insulation panel / Built-in flow meter.

Flexibility: Optional magnet for the water filter.

Comfort: Constant capacity down to -20 °C / Operating range down to -28 °C / 60 °C water outlet temperature.

Control: Additional functions with optional PCB [2 zone control, bivalent control, Smart Grid contact and more].

Connectivity: Optional Aquarea Smart and Service Cloud and integration into BMS projects.



011-1W0510
011-1W0511



Kit		Three phase (power to indoor)		
		KIT-AXC09HE8	KIT-AXC12HE8	KIT-AXC16HE8
Heating capacity / COP (A +7 °C, W 35 °C)	kW / COP	9,00/4,84	12,00/4,74	16,00/4,28
Heating capacity / COP (A +7 °C, W 55 °C)	kW / COP	9,00/2,94	12,00/2,88	16,00/2,71
Heating capacity / COP (A +2 °C, W 35 °C)	kW / COP	9,00/3,59	12,00/3,44	16,00/3,10
Heating capacity / COP (A +2 °C, W 55 °C)	kW / COP	9,00/2,21	12,00/2,19	16,00/2,13
Heating capacity / COP (A -7 °C, W 35 °C)	kW / COP	9,00/2,85	12,00/2,72	16,00/2,49
Heating capacity / COP (A -7 °C, W 55 °C)	kW / COP	9,00/2,02	12,00/1,92	16,00/1,86
Cooling capacity / EER (A 35 °C, W 7 °C)	kW / EER	7,00/3,17	10,00/2,81	12,20/2,57
Cooling capacity / EER (A 35 °C, W 18 °C)	kW / EER	7,00/5,19	10,00/5,13	12,20/3,49
Heating average climate (W 35 °C / W 55 °C)	Seasonal energy efficiency SCOP (η _s %)	4,59/3,32(181/130)	4,32/3,32(170/130)	4,08/3,20(160/125)
	Energy class ¹⁾	A+++ to D	A+++/A++	A++/A++
Heating warm climate (W 35 °C / W 55 °C)	Seasonal energy efficiency SCOP (η _s %)	5,95/4,02(235/158)	5,86/4,02(231/158)	5,86/4,05(231/159)
	Energy class ¹⁾	A+++ to D	A+++/A+++	A+++/A+++
Heating cold climate (W 35 °C / W 55 °C)	Seasonal energy efficiency SCOP (η _s %)	4,08/3,20(160/125)	4,08/3,20(160/125)	3,83/3,20(150/125)
	Energy class ¹⁾	A+++ to D	A++/A++	A++/A++
Indoor unit		WH-ADC0916H9E8	WH-ADC0916H9E8	WH-ADC0916H9E8
Sound pressure	Heat / Cool	dB(A)	33/33	33/33
Dimension	HxWxD	mm	1800x598x717	1800x598x717
Net weight		kg	126	126
Water pipe connector		Inch	R 1¼	R 1¼
A class pump	Number of speeds		Variable speed	Variable speed
	Input power (Min/Max)	W	36/152	36/152
Heating water flow (ΔT=5 K, 35 °C)		L/min	25,8	34,4
Electric backup heater		kW	9,00	9,00
Recommended fuse		A	16/16	16/16
Recommended minimum cable size, supply 1 / 2 ²⁾		mm ²	5x1,5/5x1,5	5x1,5/5x1,5
Water volume		L	185	185
Maximum DHW temperature		°C	65	65
Material inside tank			Stainless steel	Stainless steel
Tapping profile according EN16147			L	L
DHW tank ERP efficiency average / warm / cold ³⁾		A+ to F	A/A/A	A/A/B
DHW tank ERP average climate η / COPdHW		η _{wh} %/COPdHW	95/2,37	91/2,27
DHW tank ERP warm climate η / COPdHW		η _{wh} %/COPdHW	110/2,75	107/2,67
DHW tank ERP cold climate η / COPdHW		η _{wh} %/COPdHW	75/1,87	72/1,80
Outdoor unit		WH-UX09HE8	WH-UX12HE8	WH-UX16HE8
Sound power ⁴⁾	Heat	dB(A)	65	67
Dimension / Net weight	HxWxD	mm / kg	1340x900x320/108	1340x900x320/118
Refrigerant (R410A) / CO ₂ Eq.		kg / T	2,85/5,951	2,90/6,055
Piping diameter	Liquid / Gas	Inch (mm)	3/8(9,52)/5/8(15,88)	3/8(9,52)/5/8(15,88)
Pipe length range / Elevation difference (in / out)		m / m	3-30/20	3-30/20
Pre-charged pipe length / Additional gas amount		m / g/m	10/50	10/50
Operating range - outdoor ambient	Heat	°C	-28 ~ +35	-28 ~ +35
	Cool	°C	+16 ~ +43	+16 ~ +43
Water outlet	Heat / Cool	°C	20 ~ 60/5 ~ 20	20 ~ 60/5 ~ 20

1) Scale from A+++ to D. 2) Check local regulations. 3) Scale from A+ to F. 4) Sound power in accordance to 811/2013, 813/2013 and EN12102-1:2017 at +7 °C. * EER and COP calculation is based in accordance to EN14511. ** This product is designed to comply with the European drinking water standard (EU) 2020/2184. The lifespan of the product is not guaranteed in the case of the use of groundwater, such as spring water or well water, the use of tap water when salt or other impurities are contained, nor in areas of acidic water quality. Maintenance and warranty costs related to these cases are the customer's responsibility.

Accessories

CZ-TAW1B	Aquarea Smart Cloud for remote control and maintenance through wireless or wired LAN
CZ-TAW1-CBL	10 m extension cable for CZ-TAW1B
CZ-NS4P	PCB for advanced functions

Accessories

PAW-A2W-MGTFILTER	Magnet for the water filter
PAW-A2W-RTWIRED	Room thermostat
PAW-A2W-RTWIRELESS	Wireless LCD room thermostat



INTERNET CONTROL: Optional.

Aquarea T-CAP All in One H Series Three phase. Super Quiet outdoor unit. Heating and Cooling · R410A

Energy efficiency: A+++ in heating at 35 °C and A+ in DHW / "A" water pump with variable speed / Stainless steel DHW tank with U-Vacua™ insulation panel / Built-in flow meter.

Flexibility: Optional magnet for the water filter.

Comfort: Low noise level / Constant capacity down to -20 °C / Operating range down to -28 °C / 60 °C water outlet temperature.

Control: Additional functions with optional PCB (2 zone control, bivalent control, Smart Grid contact and more).

Connectivity: Optional Aquarea Smart and Service Cloud and integration into BMS projects.



011-1W0510
011-1W0511

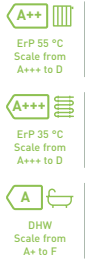

				Three phase (power to indoor)		
Kit			KIT-AQC09HE8	KIT-AQC12HE8	KIT-AQC16HE8	
Heating capacity / COP (A +7 °C, W 35 °C)		kW / COP	9,00/4,84	12,00/4,74	16,00/4,28	
Heating capacity / COP (A +7 °C, W 55 °C)		kW / COP	9,00/2,94	12,00/2,88	16,00/2,71	
Heating capacity / COP (A +2 °C, W 35 °C)		kW / COP	9,00/3,59	12,00/3,44	16,00/3,10	
Heating capacity / COP (A +2 °C, W 55 °C)		kW / COP	9,00/2,21	12,00/2,19	16,00/2,13	
Heating capacity / COP (A -7 °C, W 35 °C)		kW / COP	9,00/2,85	12,00/2,72	16,00/2,49	
Heating capacity / COP (A -7 °C, W 55 °C)		kW / COP	9,00/2,02	12,00/1,92	16,00/1,86	
Cooling capacity / EER (A 35 °C, W 7 °C)		kW / EER	7,00/3,17	10,00/2,81	12,20/2,57	
Cooling capacity / EER (A 35 °C, W 18 °C)		kW / EER	7,00/5,19	10,00/5,13	12,20/3,49	
Heating average climate (W 35 °C / W 55 °C)		Seasonal energy efficiency SCOP (η _s %)	4,59/3,32(181/130)	4,32/3,32(170/130)	4,08/3,20(160/125)	
		Energy class ¹⁾	A+++ to D	A++/A++	A++/A++	
Heating warm climate (W 35 °C / W 55 °C)		Seasonal energy efficiency SCOP (η _s %)	5,95/4,02(235/158)	5,86/4,02(231/158)	5,86/4,05(231/159)	
		Energy class ¹⁾	A+++ to D	A+++/A+++	A+++/A+++	
Heating cold climate (W 35 °C / W 55 °C)		Seasonal energy efficiency SCOP (η _s %)	4,08/3,20(160/125)	4,08/3,20(160/125)	3,83/3,20(150/125)	
		Energy class ¹⁾	A+++ to D	A++/A++	A++/A++	
Indoor unit			WH-ADC0916H9E8	WH-ADC0916H9E8	WH-ADC0916H9E8	
Sound pressure	Heat / Cool	dB(A)	33/33	33/33	33/33	
Dimension	HxWxD	mm	1800x598x717	1800x598x717	1800x598x717	
Net weight		kg	126	126	126	
Water pipe connector		Inch	R 1½	R 1½	R 1½	
A class pump	Number of speeds		Variable speed	Variable speed	Variable speed	
	Input power (Min/Max)	W	36/152	36/152	36/152	
Heating water flow (ΔT=5 K, 35 °C)		L/min	25,8	34,4	45,9	
Electric backup heater		kW	9,00	9,00	9,00	
Recommended fuse		A	16/16	16/16	16/16	
Recommended minimum cable size, supply 1 / 2 ²⁾		mm ²	5x1,5/5x1,5	5x1,5/5x1,5	5x1,5/5x1,5	
Water volume		L	185	185	185	
Maximum DHW temperature		°C	65	65	65	
Material inside tank			Stainless steel	Stainless steel	Stainless steel	
Tapping profile according EN16147			L	L	L	
DHW tank ERP efficiency average / warm / cold ³⁾		A+ to F	A/A/A	A/A/A	A/A/B	
DHW tank ERP average climate η / COPdHW		η _{wh} % / COPdHW	95/2,37	95/2,37	91/2,27	
DHW tank ERP warm climate η / COPdHW		η _{wh} % / COPdHW	110/2,75	110/2,75	107/2,67	
DHW tank ERP cold climate η / COPdHW		η _{wh} % / COPdHW	75/1,87	75/1,87	72/1,80	
Outdoor unit			WH-UQ09HE8	WH-UQ12HE8	WH-UQ16HE8	
Sound power ⁴⁾	Heat	dB(A)	58	58	62	
Dimension / Net weight	HxWxD	mm / kg	1410x1283x320/151	1410x1283x320/151	1410x1283x320/161	
Refrigerant (R410A) / CO ₂ Eq.		kg / T	2,85/5,951	2,85/5,951	2,99/6,243	
Piping diameter	Liquid / Gas	Inch (mm)	3/8(9,52)/5/8(15,88)	3/8(9,52)/5/8(15,88)	3/8(9,52)/5/8(15,88)	
Pipe length range / Elevation difference (in / out)		m / m	3~30/20	3~30/20	3~30/20	
Pre-charged pipe length / Additional gas amount		m / g/m	10/50	10/50	10/50	
Operating range - outdoor ambient	Heat	°C	-28~+35	-28~+35	-28~+35	
	Cool	°C	+16~+43	+16~+43	+16~+43	
Water outlet		Heat / Cool	°C	20~60/5~20	20~60/5~20	20~60/5~20

1) Scale from A+++ to D. 2) Check local regulations. 3) Scale from A+ to F. 4) Sound power in accordance to 811/2013, 813/2013 and EN12102-1:2017 at +7 °C. * EER and COP calculation is based in accordance to EN14511. ** This product is designed to comply with the European drinking water standard (EU) 2020/2184. The lifespan of the product is not guaranteed in the case of the use of groundwater, such as spring water or well water, the use of tap water when salt or other impurities are contained, nor in areas of acidic water quality. Maintenance and warranty costs related to these cases are the customer's responsibility.

Accessories	
CZ-TAW1B	Aquarea Smart Cloud for remote control and maintenance through wireless or wired LAN
CZ-TAW1-CBL	10 m extension cable for CZ-TAW1B
CZ-NS4P	PCB for advanced functions

Accessories	
PAW-A2W-MGTFILTER	Magnet for the water filter
PAW-A2W-RTWIRED	Room thermostat
PAW-A2W-RTWIRELESS	Wireless LCD room thermostat



INTERNET CONTROL: Optional.

Aquarea T-CAP Bi-bloc K Series Single phase / Three phase. Heating and Cooling · R32

Energy efficiency: A+++ in heating at 35 °C and A+ in DHW / "A" water pump with variable speed / Built-in flow meter.

Flexibility: Built-in magnetic water filter.

Comfort: Constant capacity down to -20 °C / Operating range down to -28 °C / 60 °C hot water even at -10 °C outside temperature.

Control: Optimised user interface and improved features (2 zone control, bivalent control).

Connectivity: Optional Aquarea Smart and Service Cloud and integration into BMS projects.



		Single phase (power to indoor)			Three phase (power to indoor)		
		KIT-WXC09K3E5	—	KIT-WXC09K3E8	—	—	—
		KIT-WXC09K6E5	KIT-WXC12K6E5	—	—	—	—
		—	—	KIT-WXC09K9E8	KIT-WXC12K9E8	KIT-WXC16K9E8	—
Heating capacity / COP (A +7 °C, W 35 °C)	kW / COP	9,00/5,03	12,10/4,84	9,00/5,03	12,10/4,84	16,00/4,38	—
Heating capacity / COP (A +7 °C, W 55 °C)	kW / COP	9,00/3,07	12,10/3,04	9,00/3,07	12,10/3,04	16,00/2,72	—
Heating capacity / COP (A +2 °C, W 35 °C)	kW / COP	9,00/3,69	12,00/3,44	9,00/3,69	12,00/3,44	16,00/3,10	—
Heating capacity / COP (A +2 °C, W 55 °C)	kW / COP	9,00/2,31	12,00/2,29	9,00/2,31	12,00/2,29	16,00/2,07	—
Heating capacity / COP (A -7 °C, W 35 °C)	kW / COP	9,00/3,00	12,00/2,72	9,00/3,00	12,00/2,72	16,00/2,39	—
Heating capacity / COP (A -7 °C, W 55 °C)	kW / COP	9,00/2,10	12,00/2,29	9,00/2,10	12,00/2,29	16,00/1,71	—
Cooling capacity / EER (A 35 °C, W 7 °C)	kW / EER	8,80/3,11	10,70/2,68	8,80/3,11	10,70/2,68	13,40/2,64	—
Cooling capacity / EER (A 35 °C, W 18 °C)	kW / EER	8,80/4,63	10,70/3,92	8,80/4,63	10,70/3,92	13,40/2,64	—
Heating average climate (W 35 °C / W 55 °C)	Seasonal energy efficiency	SCOP (η _s %)	4,96/3,57(195/140)	4,96/3,57(195/140)	4,96/3,57(195/140)	4,58/3,46(180/135)	4,46/3,31(176/129)
	Energy class ¹⁾		A+++ / A++	A+++ / A++	A+++ / A++	A+++ / A++	A+++ / A++
Heating warm climate (W 35 °C / W 55 °C)	Seasonal energy efficiency	SCOP (η _s %)	6,47/4,34(256/171)	6,47/4,34(256/171)	6,47/4,34(256/171)	6,47/4,34(256/171)	5,88/4,09(232/160)
	Energy class ¹⁾		A+++ / A+++	A+++ / A+++	A+++ / A+++	A+++ / A+++	A+++ / A+++
Heating cold climate (W 35 °C / W 55 °C)	Seasonal energy efficiency	SCOP (η _s %)	4,31/3,26(169/127)	4,31/3,26(169/127)	4,31/3,26(169/127)	4,31/3,26(169/127)	3,83/3,20(150/125)
	Energy class ¹⁾		A++ / A++	A++ / A++	A++ / A++	A++ / A++	A++ / A++
Indoor unit 3 kW electric heater		WH-SXC09K3E5	—	WH-SXC09K3E8	—	—	—
Indoor unit 6 kW electric heater		WH-SXC09K6E5	WH-SXC12K6E5	—	—	—	—
Indoor unit 9 kW electric heater		—	—	WH-SXC09K9E8	WH-SXC12K9E8	WH-SXC16K9E8	—
Sound pressure	Heat / Cool	dB(A)	33/33	33/33	33/33	33/33	33/33
Dimension	H x W x D	mm	892 x 500 x 348	892 x 500 x 348	892 x 500 x 348	892 x 500 x 348	892 x 500 x 348
Net weight 3 kW / 6 kW / 9 kW		kg	40/41 / —	—/41 / —	40 / —/41	— / —/41	— / —/42
Water pipe connector		Inch	R 1¼	R 1¼	R 1¼	R 1¼	R 1¼
A class pump	Number of speeds		Variable speed	Variable speed	Variable speed	Variable speed	Variable speed
	Input power	W	145	145	145	145	173
Heating water flow (ΔT=5 K, 35 °C)		L/min	25,8	34,4	25,8	34,4	45,9
Outdoor unit		WH-UXZ09K5	WH-UXZ12K5	WH-UXZ09K8	WH-UXZ12K8	WH-UXZ16K8	—
Sound power ²⁾	Heat	dB(A)	65	65	65	65	65
Dimension	H x W x D	mm	1340 x 900 x 320	1340 x 900 x 320	1340 x 900 x 320	1340 x 900 x 320	1340 x 900 x 320
Net weight		kg	88	88	90	90	103
Refrigerant (R32) / CO ₂ Eq.		kg / T	1,60/1,080	1,60/1,080	1,60/1,080	1,60/1,080	1,83/1,235
Piping diameter	Liquid / Gas	Inch (mm)	1/4(6,35)/1/2(12,70)	1/4(6,35)/1/2(12,70)	1/4(6,35)/1/2(12,70)	1/4(6,35)/1/2(12,70)	1/4(6,35)/1/2(12,70)
Pipe length range / Elevation difference (in / out)		m	3-30/20	3-30/20	3-30/20	3-30/20	3-30/20
Pre-charged pipe length / Additional gas amount		m / g/m	10/30	10/30	10/30	10/30	10/30
Operating range - outdoor ambient	Heat	°C	-28 ~ +35	-28 ~ +35	-28 ~ +35	-28 ~ +35	-28 ~ +35
	Cool	°C	+10 ~ +43	+10 ~ +43	+10 ~ +43	+10 ~ +43	+10 ~ +43
Water outlet ³⁾	Heat / Cool	°C	20 ~ 60/5 ~ 20	20 ~ 60/5 ~ 20	20 ~ 60/5 ~ 20	20 ~ 60/5 ~ 20	20 ~ 60/5 ~ 20

Electrical information	Heater	3 kW	6 kW	6 kW	3 kW	9 kW	9 kW	9 kW
Electric backup heater	kW	3,00	6,00	6,00	3,00	9,00	9,00	9,00
Recommended fuse	A	30/15 or 16	30/30	30/30	20/15 or 16	20/20	20/20	20/20
Recommended minimum cable size, supply 1 / 2 ⁴⁾	mm ²	3x4,0/3x1,5	3x4,0/3x4,0	3x4,0/3x4,0	5x1,5/3x1,5	5x1,5/5x1,5	5x1,5/5x1,5	5x2,5/5x1,5

1) Scale from A+++ to D. 2) Sound power level in accordance to EN12102 under conditions of the EN14825. 3) Between outdoor ambient -10 °C and -15 °C, the water outlet temperature gradually decreases from 60 °C to 55 °C. 4) Check local regulations. * Available in Summer 2024. ** EER and COP classification is at 230 V only in accordance with EU directive 2003/32/EC. *** This product is designed to comply with the European drinking water standard (EU) 2020/2184. The lifespan of the product is not guaranteed in the case of the use of groundwater, such as spring water or well water, the use of tap water when salt or other impurities are contained, nor in areas of acidic water quality. Maintenance and warranty costs related to these cases are the customer's responsibility.

Accessories	
CZ-RTW1	Optional remote controller for 2 zone control. K and L Series
PAW-TD20C1E5-1	Tank 200 L - Stainless steel
PAW-TD30C1E5-1	Tank 300 L - Stainless steel
PAW-TA20C1E5STD	Tank 200 L - Enamelled
PAW-TA30C1E5STD	Tank 300 L - Enamelled
PAW-3WYVLV-HW	3 way valve for DHW tanks
CZ-NV2	3 way valve kit to fit inside the hydrokit. K and L Series

Accessories	
PAW-BTANK50L-2	Buffer tank 50 L
CZ-TAW1B	Aquarea Smart Cloud for remote control and maintenance through wireless or wired LAN
CZ-TAW1-CBL	10 m extension cable for CZ-TAW1B
CZ-NS5P	PCB for advanced functions
PAW-A2W-RTWIRED	Room thermostat
PAW-A2W-RTWIREDLESS	Wireless LCD room thermostat



INTERNET CONTROL: Optional.

Aquarea T-CAP Bi-bloc H Series Single phase / Three phase. Heating and Cooling - SXC · R410A

Energy efficiency: A+++ in heating at 35 °C / "A" water pump with variable speed / Built-in flow meter.

Flexibility: Optional magnet for the water filter.

Comfort: Constant capacity down to -20 °C / Operating range down to -28 °C / 60 °C water outlet temperature.

Control: Additional functions with optional PCB (2 zone control, bivalent control, Smart Grid contact and more).

Connectivity: Optional Aquarea Smart and Service Cloud and integration into BMS projects.

011-1W0510
011-1W0511

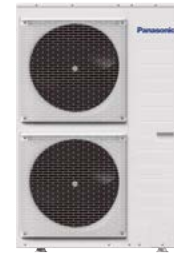

Kit	Single phase (power to indoor)			Three phase (power to indoor)			
	KIT-WXC09H3E5	KIT-WXC12H6E5	KIT-WXC09H3E8	KIT-WXC12H9E8	KIT-WXC16H9E8		
Heating capacity / COP (A +7 °C, W 35 °C)	kW / COP	9,00/4,84	12,00/4,74	9,00/4,84	12,00/4,74	16,00/4,28	
Heating capacity / COP (A +7 °C, W 55 °C)	kW / COP	9,00/2,94	12,00/2,88	9,00/2,94	12,00/2,88	16,00/2,71	
Heating capacity / COP (A +2 °C, W 35 °C)	kW / COP	9,00/3,59	12,00/3,44	9,00/3,59	12,00/3,44	16,00/3,10	
Heating capacity / COP (A +2 °C, W 55 °C)	kW / COP	9,00/2,21	12,00/2,19	9,00/2,21	12,00/2,19	16,00/2,13	
Heating capacity / COP (A -7 °C, W 35 °C)	kW / COP	9,00/2,85	12,00/2,72	9,00/2,85	12,00/2,72	16,00/2,49	
Heating capacity / COP (A -7 °C, W 55 °C)	kW / COP	9,00/2,02	12,00/1,92	9,00/2,02	12,00/1,92	16,00/1,86	
Cooling capacity / EER (A 35 °C, W 7 °C)	kW / EER	7,00/3,17	10,00/2,81	7,00/3,17	10,00/2,81	12,20/2,57	
Cooling capacity / EER (A 35 °C, W 18 °C)	kW / EER	7,00/5,19	10,00/5,13	7,00/5,19	10,00/5,13	12,20/3,49	
Heating average climate (W 35 °C / W 55 °C)	Seasonal energy efficiency	SCOP (η _s %)	4,59/3,32(181/130)	4,32/3,32(170/130)	4,59/3,32(181/130)	4,32/3,32(170/130)	4,08/3,20(160/125)
	Energy class		A+++ to D	A+++/A++	A+++/A++	A+++/A++	A++/A++
Heating warm climate (W 35 °C / W 55 °C)	Seasonal energy efficiency	SCOP (η _s %)	5,95/4,02(235/158)	5,86/4,02(231/158)	5,95/4,02(235/158)	5,86/4,02(231/158)	5,86/4,05(231/159)
	Energy class		A+++ to D	A+++/A+++	A+++/A+++	A+++/A+++	A+++/A+++
Heating cold climate (W 35 °C / W 55 °C)	Seasonal energy efficiency	SCOP (η _s %)	4,08/3,20(160/125)	4,08/3,20(160/125)	4,08/3,20(160/125)	4,08/3,20(160/125)	3,83/3,20(150/125)
	Energy class		A+++ to D	A++/A++	A++/A++	A++/A++	A++/A++
Indoor unit			WH-SXC09H3E5	WH-SXC12H6E5	WH-SXC09H3E8	WH-SXC12H9E8	WH-SXC16H9E8
Sound pressure	Heat / Cool	dB(A)	33/33	33/33	33/33	33/33	33/33
Dimension	HxWxD	mm	892x500x340	892x500x340	892x500x340	892x500x340	892x500x340
Net weight		kg	43	43	43	44	45
Water pipe connector		Inch	R 1½	R 1½	R 1½	R 1½	R 1½
A class pump	Number of speeds		Variable speed	Variable speed	Variable speed	Variable speed	Variable speed
	Input power (Min/Max)	W	32/102	34/110	32/102	34/110	30/105
Heating water flow (ΔT=5 K, 35 °C)		L/min	25,8	34,4	25,8	34,4	45,9
Electric backup heater		kW	3,00	6,00	3,00	9,00	9,00
Recommended fuse		A	30/30	30/30	16/16	16/16	16/16
Recommended minimum cable size, supply 1 / 2 ¹⁾		mm ²	3x4,0 ou 6,0/3x4,0	3x4,0 ou 6,0/3x4,0	5x1,5/3x1,5	5x1,5/5x1,5	5x1,5/5x1,5
Outdoor unit			WH-UX09HE5	WH-UX12HE5	WH-UX09HE8	WH-UX12HE8	WH-UX16HE8
Sound power ²⁾	Heat	dB(A)	66	66	65	65	67
Dimension	HxWxD	mm	1340x900x320	1340x900x320	1340x900x320	1340x900x320	1340x900x320
Net weight		kg	101	101	108	108	118
Refrigerant (R410A) / CO ₂ Eq.		kg / T	2,85/5,951	2,85/5,951	2,85/5,951	2,85/5,951	2,90/6,055
Piping diameter	Liquid / Gas	Inch (mm)	3/8(9,52)/5/8(15,88)	3/8(9,52)/5/8(15,88)	3/8(9,52)/5/8(15,88)	3/8(9,52)/5/8(15,88)	3/8(9,52)/5/8(15,88)
Pipe length range		m	3-30	3-30	3-30	3-30	3-30
Elevation difference (in / out)		m	20	20	20	20	20
Pre-charged pipe length		m	10	10	10	10	10
Additional gas amount		g/m	50	50	50	50	50
Operating range - outdoor ambient	Heat	°C	-28 ~ +35	-28 ~ +35	-28 ~ +35	-28 ~ +35	-28 ~ +35
	Cool	°C	+16 ~ +43	+16 ~ +43	+16 ~ +43	+16 ~ +43	+16 ~ +43
Water outlet	Heat / Cool	°C	20-60/5-20	20-60/5-20	20-60/5-20	20-60/5-20	20-60/5-20

1) Check local regulations. 2) Sound power in accordance to 811/2013, 813/2013 and EN12102-1:2017 at +7 °C. * EER and COP calculation is based in accordance to EN14511.

Accessories

PAW-TD20C1E5-1	Tank 200 L - Stainless steel
PAW-TD30C1E5-1	Tank 300 L - Stainless steel
PAW-TA20C1E5STD	Tank 200 L - Enamelled
PAW-TA30C1E5STD	Tank 300 L - Enamelled
PAW-3WYVLV-HW	3 way valve for DHW tanks
CZ-NV1	3 way valve kit to fit inside the hydrokit. J and H Series
PAW-BTANK50L-2	Buffer tank 50 L

Accessories

CZ-TAW1B	Aquarea Smart Cloud for remote control and maintenance through wireless or wired LAN
CZ-TAW1-CBL	10 m extension cable for CZ-TAW1B
CZ-NS4P	PCB for advanced functions
PAW-A2W-MGTFILTER	Magnet for the water filter
PAW-A2W-RTWIRED	Room thermostat
PAW-A2W-RTWIRELESS	Wireless LCD room thermostat



INTERNET CONTROL: Optional.

Aquarea T-CAP Bi-bloc H Series Three phase. Super Quiet outdoor unit. Heating and Cooling - SQC · R410A

Energy efficiency: A+++ in heating at 35 °C / "A" water pump with variable speed / Built-in flow meter.

Flexibility: Optional magnet for the water filter.

Comfort: Low noise level / Constant capacity down to -20 °C / Operating range down to -28 °C / 60 °C water outlet temperature.

Control: Additional functions with optional PCB (2 zone control, bivalent control, Smart Grid contact and more).

Connectivity: Optional Aquarea Smart and Service Cloud and integration into BMS projects.



Kit		Three phase (power to indoor)			
Kit		KIT-WQC09H3E8	KIT-WQC12H9E8	KIT-WQC16H9E8	
Heating capacity / COP (A +7 °C, W 35 °C)	kW / COP	9,00/4,84	12,00/4,74	16,00/4,28	
Heating capacity / COP (A +7 °C, W 55 °C)	kW / COP	9,00/2,94	12,00/2,88	16,00/2,71	
Heating capacity / COP (A +2 °C, W 35 °C)	kW / COP	9,00/3,59	12,00/3,44	16,00/3,10	
Heating capacity / COP (A +2 °C, W 55 °C)	kW / COP	9,00/2,21	12,00/2,19	16,00/2,13	
Heating capacity / COP (A -7 °C, W 35 °C)	kW / COP	9,00/2,85	12,00/2,72	16,00/2,49	
Heating capacity / COP (A -7 °C, W 55 °C)	kW / COP	9,00/2,02	12,00/1,92	16,00/1,86	
Cooling capacity / EER (A 35 °C, W 7 °C)	kW / EER	7,00/3,17	10,00/2,81	12,20/2,57	
Cooling capacity / EER (A 35 °C, W 18 °C)	kW / EER	7,00/5,19	10,00/5,13	12,20/3,49	
Heating average climate (W 35 °C / W 55 °C)	Seasonal energy efficiency	SCOP (η _s %)	4,59/3,32(181/130)	4,32/3,32(170/130)	4,08/3,20(160/125)
	Energy class	A+++ to D	A+++/A++	A+/A++	A+/A++
Heating warm climate (W 35 °C / W 55 °C)	Seasonal energy efficiency	SCOP (η _s %)	5,95/4,02(235/158)	5,86/4,02(231/158)	5,86/4,05(231/159)
	Energy class	A+++ to D	A+++/A+++	A+++/A+++	A+++/A+++
Heating cold climate (W 35 °C / W 55 °C)	Seasonal energy efficiency	SCOP (η _s %)	4,08/3,20(160/125)	4,08/3,20(160/125)	3,83/3,20(150/125)
	Energy class	A+++ to D	A+/A++	A+/A++	A+/A++
Indoor unit		WH-SQC09H3E8	WH-SQC12H9E8	WH-SQC16H9E8	
Sound pressure	Heat / Cool	dB(A)	33/33	33/33	
Dimension	H x W x D	mm	892 x 500 x 340	892 x 500 x 340	
Net weight		kg	43	44	
Water pipe connector		Inch	R 1/4	R 1/4	
A class pump	Number of speeds		Variable speed	Variable speed	
	Input power (Min/Max)	W	32/102	34/110	30/105
Heating water flow (ΔT=5 K, 35 °C)		L/min	25,8	34,4	45,9
Electric backup heater		kW	3,00	9,00	9,00
Recommended fuse		A	15/30	15/30	15/30
Recommended minimum cable size, supply 1 / 2 ¹⁾		mm ²	5x1,5/3x1,5	5x1,5/5x1,5	5x1,5/5x1,5
Outdoor unit		WH-UQ09H8E8	WH-UQ12H8E8	WH-UQ16H8E8	
Sound power ²⁾	Heat	dB(A)	58	58	62
Dimension	H x W x D	mm	1410 x 1283 x 320	1410 x 1283 x 320	1410 x 1283 x 320
Net weight		kg	151	151	161
Refrigerant (R410A) / CO ₂ Eq.		kg / T	2,85/5,951	2,85/5,951	2,99/6,243
Piping diameter	Liquid / Gas	Inch (mm)	3/8(9,52)/5/8(15,88)	3/8(9,52)/5/8(15,88)	3/8(9,52)/5/8(15,88)
Pipe length range		m	3-30	3-30	3-30
Elevation difference (in / out)		m	20	20	20
Pre-charged pipe length		m	10	10	10
Additional gas amount		g/m	50	50	50
Operating range - outdoor ambient	Heat	°C	-28 ~ +35	-28 ~ +35	-28 ~ +35
	Cool	°C	+16 ~ +43	+16 ~ +43	+16 ~ +43
Water outlet	Heat / Cool	°C	20 ~ 60/5 ~ 20	20 ~ 60/5 ~ 20	20 ~ 60/5 ~ 20

1) Check local regulations. 2) Sound power in accordance to 811/2013, 813/2013 and EN12102-1:2017 at +7 °C. * EER and COP calculation is based in accordance to EN14511.

Accessories	
PAW-TD20C1E5-1	Tank 200 L - Stainless steel
PAW-TD30C1E5-1	Tank 300 L - Stainless steel
PAW-TA20C1E5STD	Tank 200 L - Enamelled
PAW-TA30C1E5STD	Tank 300 L - Enamelled
PAW-3WYVLV-HW	3 way valve for DHW tanks
CZ-NV1	3 way valve kit to fit inside the hydrokit. J and H Series
PAW-BTANK50L-2	Buffer tank 50 L

Accessories	
CZ-TAW1B	Aquarea Smart Cloud for remote control and maintenance through wireless or wired LAN
CZ-TAW1-CBL	10 m extension cable for CZ-TAW1B
CZ-NS4P	PCB for advanced functions
PAW-A2W-MGTFILTER	Magnet for the water filter
PAW-A2W-RTWIRED	Room thermostat
PAW-A2W-RTWIRELESS	Wireless LCD room thermostat



INTERNET CONTROL: Optional.

Fan coils units

MORE FAN COIL OPTIONS IN CHILLERS SECTION

A large range of fan coil units dedicated to energy savings, comfort, flexibility and quality.



Energy savings and comfort

Low consumption solutions.

- High efficiency fan motor
- High level of energy performance

Silence.

- Optimised fan speed staging
- Reinforced acoustic insulation
- Profiled air diffusers

Flexibility and quality

Many factory-mounted options.

- Control
- Valve
- Air diffusion
- Condensate drain pump ...

Products fully customisable to satisfy your requirements.

- Choice of service side for hydraulic and electrical connections
- Version with or without cabinet ...

Controllers with sophisticated designs, provide a user friendly interface while enabling an easy and low cost integration to building management systems.

Optional wired remote controller for AC fan, 2-pipe and 4-pipe application.



PAW-FC-RC1

Optional wired remote controller for AC fan 2-pipe application.



PAW-FC-903AC



PAW-FC-907AC

Optional wired remote controller for EC fan, 2-pipe and 4-pipe application.



PAW-FC-903EC



PAW-FC-907EC

Smart fan coils



Built-in advanced thermostat.

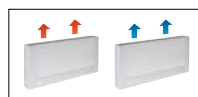

		PAW-AAIR-200-2	PAW-AAIR-700-2	PAW-AAIR-900-2	PAW-AAIR-1100-2
Total cooling capacity	Lo/Med/Hi kW	0,3/0,5/0,6	0,6/0,9/1,5	0,8/1,6/2,1	0,9/1,8/2,5
Sensible capacity	Lo/Med/Hi kW	0,2/0,4/0,6	0,5/0,9/1,3	0,7/1,3/1,9	0,9/1,6/2,3
Water flow	Lo/Med/Hi kg/h	51,1/89,4/106,3	96,0/155,2/251,1	140,8/267,2/365,7	158,1/300,3/423,6
Water pressure drop	Lo/Med/Hi kPa	3,3/5,7/6,1	1,1/2,1/4,2	1,5/5,8/10,3	1,3/5,0/10,6
Inlet water temperature	°C	10	10	10	10
Outlet water temperature	°C	15	15	15	15
Inlet air temperature	°C	27	27	27	27
Outlet air temperature	Lo/Med/Hi °C	12,8/13,2/14,9	14,6/14,8/14,0	15,8/14,6/14,4	18,1/15,2/14,7
Relative humidity of inlet air	%	47	47	47	47
Total heating capacity	Lo/Med/Hi kW	0,2/0,4/0,5	0,4/0,8/1,2	0,6/1,2/1,6	0,8/1,4/2,1
Water flow	Lo/Med/Hi kg/h	38,4/70,5/92,8	72,7/139,2/201,6	114,0/204,2/284,5	138,3/243,2/356,7
Water pressure drop	Lo/Med/Hi kPa	1,0/2,3/3,0	0,5/1,5/3,1	1,0/3,3/6,6	1,1/3,1/7,3
Inlet water temperature	°C	35	35	35	35
Outlet water temperature	°C	30	30	30	30
Inlet air temperature	°C	19	19	19	19
Outlet air temperature	Lo/Med/Hi °C	33,5/33,3/30,9	30,1/31,4/31,8	30,1/31,1/31,2	26,6/29,5/30,5
Air flow	Lo/Med/Hi m ³ /min	0,9/1,9/2,7	2,6/4,2/5,3	4,1/6,1/7,7	6,2/7,6/9,6
Maximum input power	Lo/Med/Hi W	7,0/9,0/13,0	14,0/18,0/22,0	16,0/20,0/24,0	18,0/22,0/26,5
Sound pressure	Lo/Med/Hi dB(A)	24/33/39	25/34/40	25/34/42	26/35/43
Dimension (HxWxD)	mm	579 x 735 x 129	579 x 935 x 129	579 x 1135 x 129	579 x 1335 x 129
Net weight	kg	17	20	23	26
3 Ways valve included		Yes	Yes	Yes	Yes
Touch screen thermostat		Yes	Yes	Yes	Yes

* Smart fan coils is produced by Innova.

Accessories

PAW-AAIR-LEGS-1 Set of 2 legs to protect water pipes

Accessories

PAW-AAIR-RHCABLE Motor connection cable for units with right hand hydraulic connections

Stylish floor-standing fan coils with advanced controller

The slimline of Smart fan coils delivers high efficiency climate control.

With a depth of just under 130 mm they are at the cutting edge of the market. Blending easily into the home, Smart fan coil's elegant design and product refinements are clear to see in every detail.

Exceptional ventilation efficiency means the motor uses considerably less energy (low wattage). The fan speed is continuously modulated by the temperature controller with proportional integral logic, with undoubted advantages for regulating the temperature and humidity in summer mode.

Technical focus

- 4 operation modes (auto, silent, night-time and maximum ventilation speed)
- Exclusive design
- Extremely compact (only 129 mm deep)
- Cooling and dehumidification functions possible (drain is needed)
- 3 way valve included (no overflow valve needed on the installation if more than 3 units installed)
- Touch screen thermostat

With standard cast radiators.

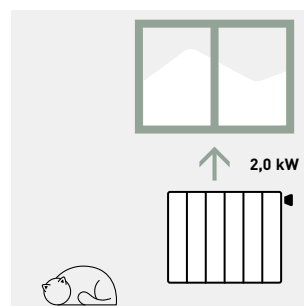

Water at 65 °C needed.

With Smart fan coil.

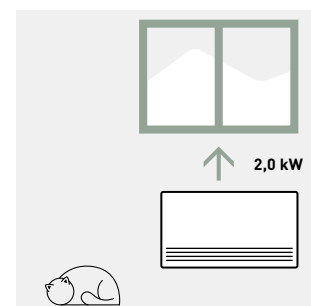

Water at 35 °C needed.

All temperature curves and capacity are available on www.panasonicproclub.com

PRO Club



Fan coil comfort AC fan

Fan coil floor and ceiling units with cooling and heating.

Cooling capacity: 0,6 to 6,9 kW.

Heating capacity: 0,6 to 7,4 kW.



Optional controller. WRC remote control.



Optional controller. SRC - mini BMS controller.



Optional controller. Electronic controller TControl POD glass.



Optional controller. Electronic controller TControl EASY 3S.



Optional controller. Wired remote controller with touch control. PAW-FC-907AC



Optional controller. Wired remote controller. PAW-FC-903AC



Optional controller. Advanced wired remote controller. PAW-FC-RC1

SEE PAGE 516 FOR MORE DETAILS ABOUT FAN COIL CONTROLLERS

Operating limits

Entering water temperature (without glycol).

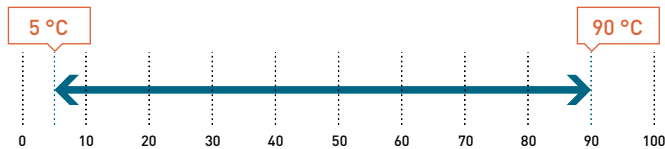

Indoor air temperature.

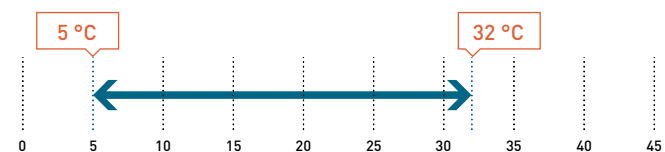

The range at a glance

- Versions: 2-pipes, 2-pipes + electric heater and 4-pipes
- 7 sizes
- 5-speed AC fan - standard factory set speeds: S1,S3,S5
- Air flow from 94 to 1064 m³/h
- Configuration: universal installation units (vertical or horizontal) with or without cabinet
- Left or right water connections
- Many air inlet/outlet configurations
- G2 air filter (G3 as an option)

Advantages

- Silent units
- New casing design for an increased robustness
- Harmonious and aesthetic RAL 9003 painted cabinet
- Valves, condensate drain pan and drain pump factory mounted
- 100% factory tested

Accessories and options

- 2 way or 3 way valves
- 4-pipes kit (additional coil)
- Circuit breakers
- Drain pump
- Electric heaters (from 500 W to 2500 W)
- Feet with/without grid
- Fuse holders
- G3 filter
- Horizontal or vertical drain guard (with valve)
- Many air inlet/outlet configurations
- Mechanical sensor for automatic change over
- Modbus communication board for Plogic
- MRC/WRC/BRC: remote controls for Plogic
- Other speeds configuration (standard factory set speeds: S1,S3,S5)
- SRC - mini BMS controller
- Suspension kit
- Plogic controller (other electromechanical or electronic control systems also available)
- TControl EASY 3S and TControl POD glass controllers (other electromechanical or electronic control systems also available)

AC SELECT.

Smart and user-friendly the new air conditioning selection program: <https://acselect.panasonic.eu/>



Technical features

Fan coil comfort AC fan			P-FC10	P-FC20	P-FC30	P-FC40	P-FC50	P-FC60	P-FC70
			S1/S3/S5 ¹⁾	S1/S3/S5 ¹⁾	S1/S3/S5 ¹⁾	S1/S3/S5 ¹⁾	S1/S3/S5 ¹⁾	S1/S3/S5 ¹⁾	S1/S3/S5 ¹⁾
2-pipes									
Total cooling capacity ²⁾	kW		0,66/1,00/1,45	0,61/0,96/1,38	0,95/1,88/2,37	1,14/2,28/3,02	1,71/3,16/4,64	2,57/4,33/5,53	3,24/5,84/6,91
Sensible capacity ²⁾	kW		0,48/0,77/1,05	0,43/0,70/1,02	0,78/1,44/1,80	0,83/1,66/2,23	1,24/2,23/3,27	1,81/3,14/4,25	2,26/4,11/4,85
Water flow ²⁾	l/h		114/172/250	105/165/238	164/324/408	196/393/520	295/544/799	443/746/953	558/1006/1190
Water pressure drop ²⁾³⁾	kPa		9,17/19,5/39,1	2,65/4,62/7,43	5,8/17,6/26,3	5,0/15,6/25,6	7,5/22,8/47,1	12,6/33,9/54,4	4,4/13,9/19,4
Heating capacity ⁴⁾	kW		0,63/1,18/1,71	0,63/1,03/1,53	1,00/1,86/2,49	1,14/2,28/3,18	1,79/3,47/4,81	2,45/4,22/5,63	3,45/6,27/7,41
Water flow ⁴⁾	l/h		109/203/295	109/177/264	172/320/429	196/393/548	308/598/829	422/727/970	594/1080/1276
Water pressure drop ³⁾⁴⁾	kPa		5,9/17,3/33,8	2,76/5,06/8,54	5,8/16,2/27,0	5,0/15,6/28,1	6,1/20,7/38,5	18,6/52,4/91,4	4,9/16,0/22,3
4-pipes									
Total cooling capacity ²⁾	kW		0,63/0,88/1,24	0,87/1,34/1,73	0,91/1,80/2,28	0,98/2,14/2,85	1,57/2,88/4,13	2,60/4,39/5,61	3,17/5,62/6,58
Sensible capacity ²⁾	kW		0,46/0,67/0,91	0,65/1,02/1,36	0,75/1,39/1,74	0,71/1,57/2,10	1,14/2,04/2,92	1,82/3,18/4,28	2,21/3,96/4,62
Water flow ²⁾	l/h		109/152/214	150/231/298	157/310/393	169/369/491	270/496/711	448/756/966	546/968/1133
Water pressure drop ²⁾³⁾	kPa		7,6/13,9/26,3	2,33/4,44/6,64	2,8/8,6/13,1	5,8/20,5/33,6	3,9/11,6/22,8	10,2/27,7/44,5	5,3/16,2/22,1
Heating capacity ⁵⁾	kW		0,63/1,00/1,41	1,00/1,40/1,68	1,28/1,81/2,13	1,22/2,21/2,85	2,01/3,19/4,08	2,71/4,24/5,33	3,65/5,00/5,90
Water flow ⁵⁾	l/h		54/86/121	86,1/121/145	110/156/183	105/190/245	173/275/351	233/365/459	314/431/508
Water pressure drop ³⁾⁵⁾	kPa		1,2/2,1/3,3	1,15/2,2/3,12	2,8/4,7/6,1	5,1/13,9/21,8	5,7/12,5/19,4	11,6/24,8/37	35,4/60,7/81,2
Sound levels									
Sound power	2-pipes	dB(A)	33/40/49	31/43/50	30/45/52	30/44/51	34/43/56	38/51/58	43/56/61
	4-pipes	dB(A)	33/40/49	31/43/50	30/45/52	30/44/51	34/46/56	38/51/58	43/56/61
Sound pressure ⁶⁾	2-pipes	dB(A)	24/31/40	22/34/41	21/36/43	21/35/42	25/37/47	29/42/49	34/47/52
	4-pipes	dB(A)	24/31/40	22/34/41	21/36/43	21/35/42	25/37/47	29/42/49	34/47/52
NR ⁶⁾	2-pipes		19/26/35	17/29/36	16/31/38	16/30/37	20/32/42	24/37/44	29/42/47
	4-pipes		19/26/35	17/29/36	16/31/38	16/30/37	20/32/42	24/37/44	29/42/47
Ventilation									
Number of fans			1	1	1	2	2	2	2
Air flow	2-pipes	m ³ /h	94/190/283	68/104/196	138/274/390	173/357/499	253/486/716	350/640/933	480/893/1064
	4-pipes	m ³ /h	95/168/253	89/161/241	132/263/369	148/335/467	242/466/671	334/614/885	470/859/1012
Filter			G2	G2	G2	G2	G2	G2	G2
Electrical data									
Power supply	Voltage	V	230	230	230	230	230	230	230
	Phase		Single phase	Single phase	Single phase	Single phase	Single phase	Single phase	Single phase
	Frequency	Hz	50/60	50/60	50/60	50/60	50/60	50/60	50/60
Consumption	2-pipes	W	13/24/36	13/18/31	16/37/45	15/37/56	28/55/72	37/75/105	53/100/147
	4-pipes	W	13/24/36	11/18/28	16/37/44	15/37/55	28/54/70	37/74/104	53/99/145
Electric heater	W		500	500	500/1000	1250	1250/2500	1250/2500	1250/2500
Water connections									
Connection type			Gas female threaded	Gas female threaded	Gas female threaded	Gas female threaded	Gas female threaded	Gas female threaded	Gas female threaded
2 or 4-pipes	Cooling	Inch	½	½	½	½	½	½	¾
4-pipes	Heating	Inch	½	½	½	½	½	½	½
Dimension									
With cabinet - without feet	LxWxH	mm	766x225x477	766x225x477	951x225x477	1136x225x477	1321x225x477	1506x225x477	1319x225x575
Without cabinet	LxWxH	mm	570x220x430	570x220x430	753x220x430	938x220x430	1122x220x430	1307x220x430	1121x220x530
Weight									
With cabinet	2-pipes	kg	19	19	22	27	30	35	35
	4-pipes	kg	20	20	23	29	32	37	37
Without cabinet	2-pipes	kg	13	13	15	20	22	26	27
	4-pipes	kg	14	14	16	22	24	28	29

1) Fan standard factory set speeds. 2) According to Eurovent standard. Air: 27 °C DB/19 °C WB, chilled water: 7 °C/12 °C. 3) Pressure loss by corresponding nominal flow. 4) According to Eurovent standard. Air: 20 °C, hot water: 45 °C/40 °C. 5) According to Eurovent standard. Air: 20 °C, hot water: 65 °C/55 °C. 6) Informative data, considering an hypothetical sound attenuation of the room and installation of 9 dB(A).



ErP compliant following COMMISSION REGULATION (EU) 2016/2281.

Fan coil comfort EC fan

Fan coil floor and ceiling units with cooling and heating.

Cooling capacity: 0,5 to 9,1 kW.

Heating capacity: 0,6 to 12,9 kW.



Optional controller. WRC remote control.



Optional controller. SRC - mini BMS controller.



Optional controller. Electronic controller TControl POD glass.



Optional controller. Electronic controller TControl EASY 3S.



Optional controller. Wired remote controller with touch control. PAW-FC-907EC



Optional controller. Wired remote controller. PAW-FC-903EC

SEE PAGE 516 FOR MORE DETAILS ABOUT FAN COIL CONTROLLERS

Operating limits

Entering water temperature (without glycol).

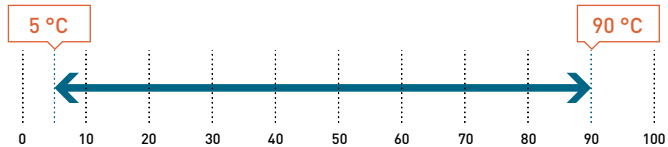

Indoor air temperature.

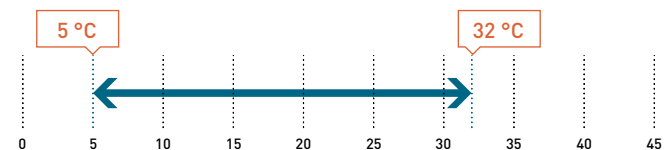

AC SELECT.

Smart and user-friendly the new air conditioning selection program: <https://acselect.panasonic.eu/>

The range at a glance

- Versions: 2-pipes, 2-pipes + electric heater and 4-pipes
- 8 sizes
- Low energy consumption EC fan: 100% controllable via a 0-10 V signal or 3 operating speeds
- Air flow from 91 to 1548 m³/h
- Configuration: universal installation units (vertical or horizontal) with or without cabinet
- Left or right water connections
- Many air inlet/outlet configurations
- G2 air filter (G3 as an accessory)

Advantages

- Excellent performances: FCEER and FCCOP up to "A"
- Silent units
- New casing design for an increased robustness
- Harmonious and aesthetic RAL 9003 painted cabinet
- Valves, condensate drain pan and drain pump factory mounted
- 100% factory tested

Accessories and options

2 way or 3 way valves
4-pipes kit (additional coil)
Circuit breakers
Drain pump
Ecospeed card for EC fans
Electric heaters (from 500 W to 2500 W)
Feet with/without grid
Fuse holders
G3 filter
Horizontal or vertical drain guard (with valve)
Many air inlet/outlet configurations
Electromechanical sensor for automatic change over
Modbus communication board for Plogic
MRC/WRC/BRC: remote controls for Plogic
Other speeds configuration (standard factory set speeds in technical features table)
SRC - mini BMS controller
Suspension kit
Plogic controller (other electromechanical or electronic control systems also available)
TControl EASY 3S and TControl POD glass controllers (other electromechanical or electronic control systems also available)



Technical features

Fan coil comfort EC fan	P-FC10		P-FC20		P-FC30		P-FC40		P-FC50		P-FC60		P-FC70		P-FC80			
	2V/5V/10V ¹⁾		2V/5V/10V ¹⁾		2V/6V/10V ¹⁾		2V/5V/10V ¹⁾		2V/7V/10V ¹⁾		2V/7V/10V ¹⁾		4V/8V/10V ¹⁾		3V/4,1V/6,4V ¹⁾			
2-pipes																		
Total cooling capacity ²⁾	kW	0,59/1,16/1,96		0,61/1,31/2,12		0,67/1,41/1,83		1,34/2,93/4,19		1,34/3,57/4,98		1,98/4,45/5,24		2,55/5,56/6,55		4,59/6,13/8,36		
Sensible capacity ²⁾	kW	0,48/1,00/1,76		0,47/1,06/1,72		0,47/1,04/1,34		0,95/2,10/3,00		1,05/2,70/3,70		1,35/3,51/4,02		1,91/4,10/4,96		3,32/4,51/6,28		
Water flow ²⁾	l/h	102/200/338		105/226/365		141/336/505		231/505/722		231/615/858		341/767/903		439/958/1128		791/1056/1440		
Water pressure drop ²⁾³⁾	kPa	7,5/25,7/69,5		1,4/4,3/9,3		5,9/21,8/42,9		6,4/24,3/46,3		4,9/28,7/53,9		7,8/35,8/49,0		2,7/12,6/17,5		11,8/19,5/34,2		
Heating capacity ⁴⁾	kW	0,67/1,30/2,31		0,68/1,53/2,52		0,80/1,72/2,66		1,11/2,48/4,46		1,38/3,89/5,19		1,95/4,93/5,82		3,05/5,81/7,17		4,63/6,39/9,28		
Water flow ⁴⁾	l/h	115/224/398		117/264/434		138/296/458		191/427/768		238/670/894		336/849/1002		525/1001/1235		798/1101/1598		
Water pressure drop ²⁾⁴⁾	kPa	6,5/20,6/59,1		1,7/5,5/12,4		4,1/14,2/30,4		4,8/18,1/51,9		3,8/25,7/44,6		12,2/70,7/97,5		3,9/13,8/20,9		11,9/21,0/41,5		
4-pipes																		
Total cooling capacity ²⁾	kW	0,51/1,02/1,80		0,57/1,20/2,18		0,75/1,84/2,93		1,03/2,20/3,52		1,17/3,45/4,39		1,69/3,90/4,69		2,44/4,88/6,06		4,44/5,86/9,07		
Sensible capacity ²⁾	kW	0,41/0,87/1,60		0,43/0,96/1,76		0,55/1,44/2,28		0,73/1,57/2,58		0,92/2,61/3,28		1,12/3,05/3,63		1,83/3,61/4,53		3,20/4,31/6,84		
Water flow ²⁾	l/h	87,8/176/310		98,2/207/376		129/317/505		177/379/606		202/594/756		291/672/808		420/841/1044		765/1009/1562		
Water pressure drop ²⁾³⁾	kPa	5,2/18,3/53,4		1,3/3,8/9,7		4,0/13,7/28,0		9,3/27,8/58,9		2,3/16,2/25,6		4,6/22,0/31,4		3,2/12,3/18,8		18,8/30,6/67,2		
Heating capacity ⁵⁾	kW	0,61/1,13/1,87		0,79/1,33/2,09		1,41/2,01/2,77		1,57/2,49/3,62		2,18/3,34/4,10		1,81/4,05/4,81		3,45/4,67/5,53		5,74/7,99/12,90		
Water flow ⁵⁾	l/h	52,5/97,3/161		68/115/180		121/173/239		135/214/312		188/288/353		156/349/414		297/402/476		494/688/1111		
Water pressure drop ²⁾⁵⁾	kPa	1,1/2,4/4,8		<1/2,0/4,8		7,9/12,3/18,6		10,9/22,2/41,1		6,5/13,6/19,6		16,1/45,3/57,5		32,2/53,9/72,4		19,2/34,5/83,1		
Sound levels																		
Sound power	2-pipes	dB(A)	34/47/60		34/47/60		31/50/59		29/44/52		30/51/57		32/54/58		40/54/59		51/56/64	
	4-pipes	dB(A)	34/47/60		34/47/60		31/50/59		29/44/56		30/51/57		32/54/58		40/54/59		51/56/64	
Sound pressure ⁶⁾	2-pipes	dB(A)	25/38/51		25/38/51		22/41/50		20/35/43		21/42/48		23/45/49		31/45/50		42/47/55	
	4-pipes	dB(A)	25/38/51		25/38/51		22/41/50		20/35/43		21/42/48		23/45/49		31/45/50		42/47/55	
NR ⁶⁾	2-pipes		20/33/46		20/33/46		17/36/45		15/30/38		16/37/43		18/40/44		26/40/45		37/42/50	
	4-pipes		20/33/46		20/33/46		17/36/45		15/30/38		16/37/43		18/40/44		26/40/45		37/42/50	
Ventilation																		
Number of fans			1		1		1		2		2		2		2		3	
Air flow	2-pipes	m ³ /h	108/228/417		98/234/413		119/257/345		170/412/678		203/577/816		245/737/912		350/850/1050		685/927/1398	
	4-pipes	m ³ /h	91/199/379		84/200/380		123/297/540		148/298/524		185/587/755		205/668/845		329/798/989		660/884/1548	
Filter			G2		G2		G2		G2		G2		G2		G2		G2	
Electrical data																		
Power supply	Voltage	V	230		230		230		230		230		230		230		230	
	Phase		Single phase		Single phase		Single phase		Single phase		Single phase		Single phase		Single phase		Single phase	
	Frequency	Hz	50/60		50/60		50/60		50/60		50/60		50/60		50/60		50/60	
Consumption	2-pipes	W	7/12/41		7/13/41		6/16/42		2/13/43		4/23/46		4/30/54		11/44/77		23/42/108	
	4-pipes	W	7/12/39		7/13/40		6/14/40		2/11/39		4/23/44		4/28/52		11/43/75		22/41/116	
Electric heater	W	500		500		500/1000		1250		1250/2500		1250/2500		1250/2500		1250/2500		
Water connections																		
Connection type			Gas female threaded		Gas female threaded		Gas female threaded		Gas female threaded		Gas female threaded		Gas female threaded		Gas female threaded		Gas female threaded	
2 or 4-pipes	Cooling	Inch	½		½		½		½		½		½		¾		¾	
4-pipes	Heating	Inch	½		½		½		½		½		½		½		½	
Dimension																		
With cabinet - without feet	L x W x H	mm	766 x 225 x 477		766 x 225 x 477		951 x 225 x 477		1136 x 225 x 477		1321 x 225 x 477		1506 x 225 x 477		1319 x 225 x 575		1506 x 225 x 575	
Without cabinet	L x W x H	mm	570 x 220 x 430		570 x 220 x 430		753 x 220 x 430		938 x 220 x 430		1122 x 220 x 430		1307 x 220 x 430		1121 x 220 x 530		1316 x 220 x 530	
Weight																		
With cabinet	2-pipes	kg	19		19		22		27		30		35		35		47	
	4-pipes	kg	20		20		23		29		32		37		37		49	
Without cabinet	2-pipes	kg	13		13		15		20		22		26		27		38	
	4-pipes	kg	14		14		16		22		24		28		29		40	

Energy efficiency class⁷⁾

Fan coil comfort EC fan		P-FC10		P-FC20		P-FC30		P-FC40		P-FC50		P-FC60		P-FC70		P-FC80	
2-pipes	FCEER	C		C		B		A		A		A		B		B	
	FCCOP	D		C		C		B		A		B		B		B	
4-pipes	FCEER	C		C		B		A		B		B		B		A	
	FCCOP	C		C		B		A		B		B		B		A	

1) Fan standard factory set speeds (voltage). 2) According to Eurovent standard. Air: 27 °C DB/19 °C WB, chilled water: 7 °C/12 °C. 3) Pressure loss by corresponding nominal flow. 4) According to Eurovent standard. Air: 20 °C, hot water: 45 °C/40 °C. 5) According to Eurovent standard. Air: 20 °C, hot water: 65 °C/55 °C. 6) Informative data, considering a hypothetical sound attenuation of the room and installation of 9 dB(A). 7) According to Eurovent.



ErP compliant following COMMISSION REGULATION (EU) 2016/2281.

Fan coil wall AC fan

Fan coil wall-mounted units with cooling and heating.

Cooling capacity: 1,0 to 4,0 kW.

Heating capacity: 1,4 to 4,5 kW.



Optional controller. WRC remote control.



Optional controller. SRC - mini BMS controller.



Optional controller. Electronic controller TControl POD glass.



Optional controller. Electronic controller TControl EASY 3S.



Optional controller. Wired remote controller with touch control. PAW-FC-907AC



Optional controller. Wired remote controller. PAW-FC-903AC



Optional controller. Advanced wired remote controller. PAW-FC-RC1

SEE PAGE 516 FOR MORE DETAILS ABOUT FAN COIL CONTROLLERS

Operating limits

Entering water temperature (without glycol).

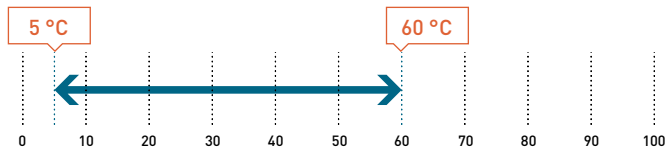

Indoor air temperature.

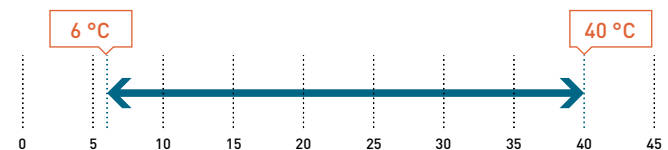

AC SELECT.

Smart and user-friendly the new air conditioning selection program: <https://acselect.panasonic.eu/>



The range at a glance

- Versions (2-pipes): infrared without valve (IR SV), infrared with valve (IR AV) and terminal block without valve (TB SV)
- 4 sizes
- 3-speed AC fan
- Air flow from 280 to 850 m³/h
- G1 cleanable air filter

Advantages

- Reversible
- Aesthetic design
- Light for easy installation
- Silent units
- Very easy servicing through a removable front panel
- Cleanable synthetic-type air filter

Accessories and options

- 2 way or 3 way valves
- Modbus communication board for Plogic
- SRC - mini BMS controller
- Plogic controller (other electromechanical or electronic control systems also available)
- TControl EASY 3S and TControl POD glass controllers (other electromechanical or electronic control systems also available)
- WRC: wall-mounted remote control for Plogic

Technical features

Fan coil wall AC fan		P-FW07		P-FW09		P-FW18		P-FW22		
		S2/S3/S4 ¹⁾		S2/S3/S4 ¹⁾		S2/S3/S4 ¹⁾		S2/S3/S4 ¹⁾		
2-pipes, without valve										
Total cooling capacity ²⁾		kW	1,00/1,34/1,69		1,58/1,79/2,50		2,78/3,05/3,60		2,93/3,29/4,00	
Sensible capacity ²⁾		kW	0,72/0,97/1,20		1,21/1,37/1,87		2,12/2,39/2,74		2,28/2,62/3,11	
Water flow ²⁾		l/h	172/231/291		270/308/431		479/525/620		505/565/687	
Water pressure drop ²⁾		kPa	18,6/24,9/31,4		18,5/21,4/31,0		34,6/40,0/52,3		37,2/42,8/54,9	
Heating capacity ³⁾		W	1,42/1,62/1,72		1,68/1,92/2,80		2,99/3,30/4,10		3,18/3,63/4,50	
Water flow ³⁾		l/h	245/279/296		289/331/482		515/568/706		548/625/775	
Water pressure drop ³⁾		kPa	17,6/23,4/26,5		21,4/23,5/28,6		39,9/46,3/64,7		41,7/55,0/85,8	
Sound levels										
Sound power		dB(A)	45/49/51		40/43/52		47/50/54		50/55/60	
Sound pressure ⁴⁾		dB(A)	30/33/35		32/36/40		39/41/43		39/43/48	
NR ⁴⁾		dB(A)	32/36/38		34/39/44		40/43/46		43/46/50	
Ventilation										
Number of fans			1		1		1		1	
Air flow		m ³ /h	282/321/360		367/413/551		532/592/680		617/709/850	
Filter			G1		G1		G1		G1	
Electrical data										
Power supply	Voltage	V	230		230		230		230	
	Phase		Single phase		Single phase		Single phase		Single phase	
	Frequency	Hz	50		50		50		50	
Consumption	Cooling	W	39/42/62		30/33/40		44/48/53		50/55/69	
	Heating	W	39/42/62		27/30/50		42/45/60		46/51/66	
Water connections										
Connection type			Gas female threaded		Gas female threaded		Gas female threaded		Gas female threaded	
Connections		Inch	½		½		½		½	
Dimension and weight										
Dimension	L x W x H	mm	845 x 180 x 275		845 x 180 x 275		940 x 200 x 298		940 x 200 x 298	
Weight		kg	11		11		13		13	
Fan coil wall AC fan				P-FW09		P-FW22				
				S2/S3/S4 ¹⁾		S2/S3/S4 ¹⁾				
2-pipes, with valve										
Total cooling capacity ²⁾		kW	1,11/1,25/1,40		2,32/2,68/3,10					
Sensible capacity ²⁾		kW	0,91/1,08/1,25		1,68/1,98/2,28					
Water flow ²⁾		l/h	191/215/241		400/460/532					
Water pressure drop ²⁾		kPa	14,9/16,8/18,8		42,4/50,8/61,5					
Heating capacity ³⁾		W	1,29/1,61/2,00		2,51/2,75/3,30					
Water flow ³⁾		l/h	222/277/344		432/474/568					
Water pressure drop ³⁾		kPa	16,1/21,3/28,2		45,8/48,6/54,1					
Sound levels										
Sound power		dB(A)	44/50/54		53/57/60					
Sound pressure ⁴⁾		dB(A)	32/36/40		39/43/48					
NR ⁴⁾		dB(A)	27/31/37		34/37/41					
Ventilation										
Number of fans			1		1					
Air flow		m ³ /h	150/250/400		290/400/600					
Filter			G1		G1					
Electrical data										
Power supply	Voltage	V	230		230					
	Phase		Single phase		Single phase					
	Frequency	Hz	50		50					
Consumption	Cooling	W	35/38/43		50/58/69					
	Heating	W	30/33/43		50/58/69					
Water connections										
Connection type			Gas female threaded		Gas female threaded					
Connections		Inch	½		½					
Dimension and weight										
Dimension	L x W x H	mm	845 x 180 x 275		940 x 200 x 298					
Weight		kg	11		13					

1) Fan standard factory set speeds. 2) According to Eurovent standard. Air: 27 °C DB/19 °C WB, chilled water: 7 °C/12 °C. 3) According to Eurovent standard. Air: 20 °C, hot water: 45 °C/40 °C. 4) Informative data, considering an hypothetical sound attenuation of the room and installation of 9 dB(A).



ErP compliant following COMMISSION REGULATION (EU) 2016/2281.

Sanitary tanks

Combo tanks.

The best option to combine with Mono-bloc units. DHW tank with buffer tank. Designed for retrofit applications, the DHW tank with a buffer tank is particularly suitable for fast integration on an existing installation. Easy to install, nice looking, high efficiency for DHW production and for heating.

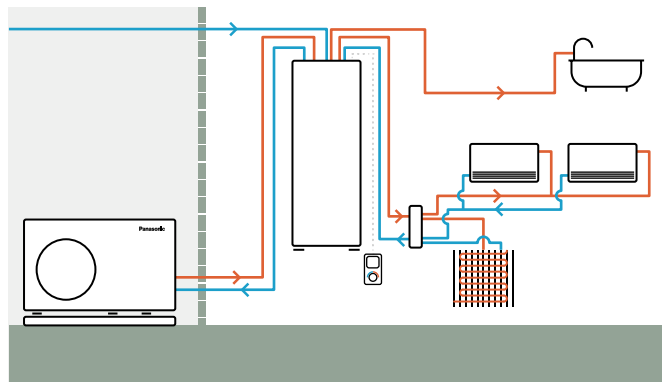

Reference	PAW-TD20B8E3-2		PAW-TD23B6E5	
Material	Enamelled		Stainless steel	
Dimension HxWxD	mm 1770x640x690		1750x600x646	
Weight (empty)	kg 150		111	
Water volume	L 185 + 80		230 + 60	
Power supply	V, Phase, Hz 230, 1, 50		230, 1, 50	
	Hot water tank		Hot water tank	
Water volume	L	185	230	Buffer tank
Max working pressure	MPa (bar)	0,8 (8)	1,0 (10)	60
Pressure test	MPa (bar)	1,2 (12)	1,5 (15)	0,3 (3,0)
Max working temp	°C	90	80	80
Connections	mm	Ø22	Ø22	Ø22, copper
Material	S 275 JR vitrified		EN 14521	EN 14521
Insulation	Material, t=mm	PUR, 50	PUR, 50	PUR, 50
Heating coil surface	m ²	2,1	—	—
Electrical heater	W	3000	2800	—
Energy loss at 65 °C ¹⁾	kWh/24h	1,3	1,25	—
Energy efficiency class (from A+ to F)²⁾		B	B	A
Standing loss	W	53	46	29

1) Tested pursuant to EN 12897:2006. 2) EU Regulation 812/2013. * Enamelled Combo tank is produced by Lapesa. Stainless steel Combo tank is produced by OSO.



Buffer tanks.

Reference	PAW-BTANK50L-2	PAW-BTANK100L	PAW-BTANKG200L	PAW-BTANKG260L
Water volume	L 48	100	194	252
Energy losses	W 35	55	60	83
Energy efficiency class (from A+ to F)	B	B	B	C
Material	Stainless steel	Stainless steel	Carbon Steel	Carbon Steel
Dimension (Height / Diameter)	mm 636 / 430	1175 / 430	983 / 620	1239 / 620
Net weight	kg 17	28	41	46

* Automatic air vent and drain cock are included. Built-in pocket sensor (sensor not included). ** 50 and 100 L Buffer Tanks are produced by OSO. 200 and 260 L Buffer Tanks are produced by Lapesa.



Enamelled tanks.

Type	Enamelled tank				Enamelled 2 coils tank (for bivalent solar + HP)	Square tank	
Reference		PAW-TA15C1E5	PAW-TA20C1E5STD	PAW-TA30C1E5STD	PAW-TA40C1E5STD	PAW-TA30C2E5STD	PAW-TA20C1E5C
Water volume	L	167	200	290	380	350	200
Maximum water temperature	°C	90	95	95	95	95	95
Dimension (Hight / Diameter)	mm	1297/560	1340/610	1800/610	1835/670	1835/670	1550x600x600
Weight / filled with water	kg	88/255	90/280	120/389	191/572	169/519	134/327
Electric heater	kW	—	3,00	3,00	3,00	3,00	—
Power supply	V	—	230	230	230	230	—
Material inside tank		Enamelled	Enamelled	Enamelled	Enamelled	Enamelled	Enamelled
Exchange surface	m ²	1,8	1,8	2,6	3,8	3,5 / 1,2	1,83
Energy loss at 65 °C ¹⁾	kWh/24h	1,08	1,37	1,61	1,76	1,76	1,37
3 way valve accessory PAW-3WYVLV-HW, CZ-NV1 ou CZ-NV2		Optional	Optional	Optional	Optional	Optional	Built-in 3 way valve
20 m temperature sensor cable included		Yes	Yes	Yes	Yes	Yes	Yes
Energy losses	W	45	57	67	73	73	57
Energy efficiency class (from A+ to F)		B	B	B	B	B	B
Warranty of the inner vessel		2 Years	2 Years	2 Years	2 Years	2 Years	2 Years
Maintenance required		Anode ²⁾	Anode ²⁾	Anode ²⁾	Anode ²⁾	Anode ²⁾	Anode ²⁾

1) Insulated tested under EN12897. 2) Refer to the service manual for further details. * PAW-TA15C1E5 is produced by Lapesa. All other Enamelled tanks and Square tank are produced by AEmail.



Stainless steel tanks.

Reference		PAW-TD20C1E5-1	PAW-TD30C1E5-1	PAW-TD30C1E5HI-1
Water volume	L	192	284	280
Maximum water temperature	°C	75	75	75
Dimension (Hight / Diameter)	mm	1270/595	1750/595	1750 / 595
Weight / filled with water	kg	50/—	61/—	65 / —
Electric heater	kW	1,5	1,5	1,5
Power supply	V	230	230	230
Material inside tank		Stainless steel	Stainless steel	Stainless steel
Exchange surface	m ²	1,8	1,8	2,35
Energy loss at 65 °C ¹⁾	kWh/24h	1,01	1,18	1,18
3 way valve accessory PAW-3WYVLV-HW, CZ-NV1 ou CZ-NV2		Optional	Optional	Optional
20 m temperature sensor cable included		Yes	Yes	Yes
Energy losses	W	42	49	49
Energy efficiency class (from A+ to F)		A	A	A
Warranty		2 Years	2 Years	2 Years
Maintenance required		No	No	No

1) Insulated tested under EN12897. * Stainless steel tanks are produced by OSO.

Accessories for sanitary tanks

PAW-3WYVLV-HW	3 way valve for DHW tanks
CZ-NV1	3 way valve kit to fit inside the hydrokit. J and H Series
CZ-NV2	3 way valve kit to fit inside the hydrokit. K and L Series

Accessories for sanitary tanks

PAW-EANODE2	Impressed current anode for 200 L Stainless steel tanks
PAW-EANODE3	Impressed current anode for 300 L Stainless steel tanks

Heat recovery ventilation unit

The heat recovery ventilation unit is design not only to provide a good indoor air quality, but it is also designed to recover heat that would otherwise be lost throughout ventilation. These heat recovery ventilation systems are used to assist in the retention of heat.

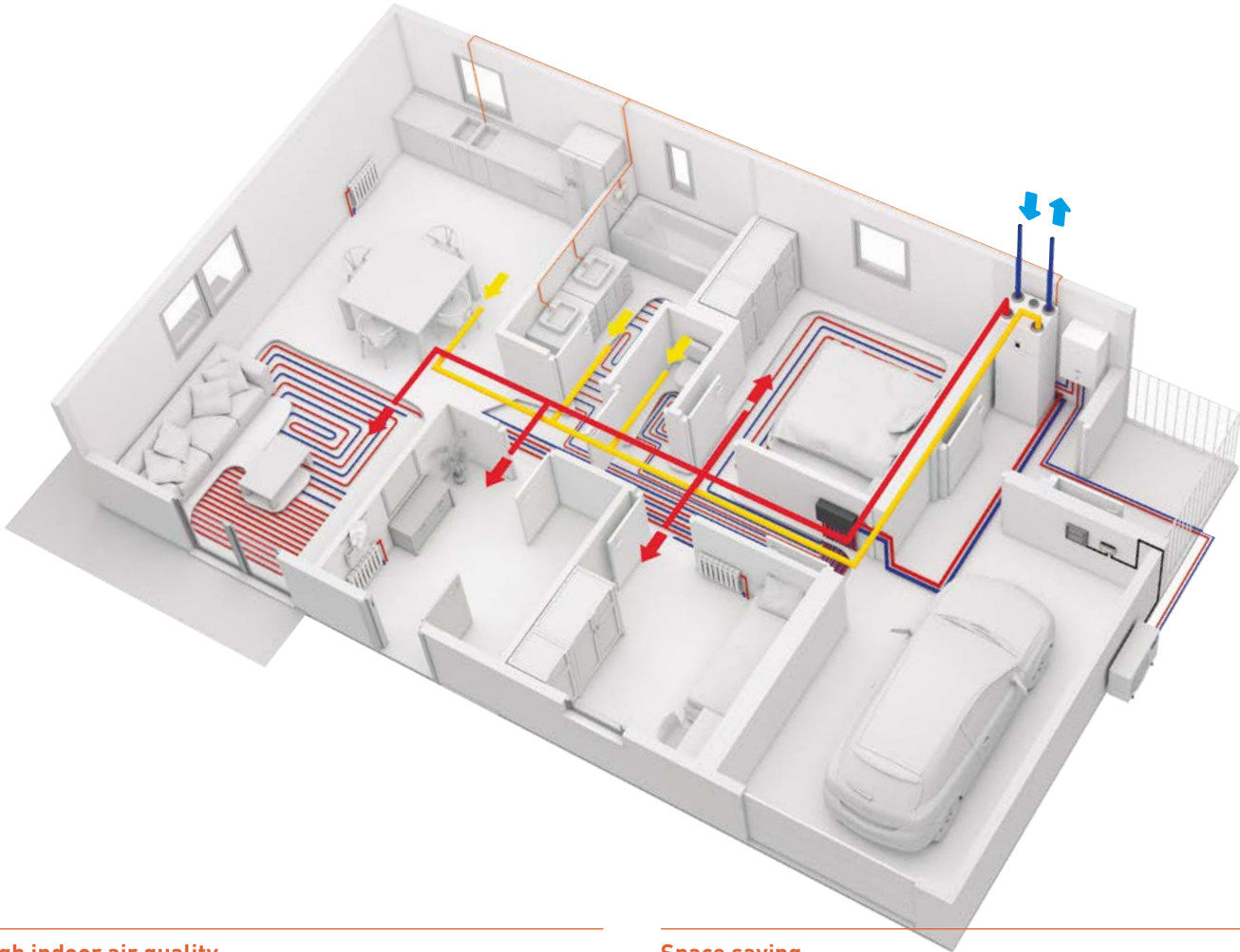

High indoor air quality

The unit is designed to provide fresh filtered air into the home, while keeping a high thermal comfort.

Energy saving

Most of the energy from the exhausted air is used to precondition the incoming air, leading to lower heating requirements in the building.

Space saving

The compact ventilation unit can be installed over the DHW square tank or the Aquarea All in One Compact indoor unit for an space-saving solution.

Better user interface

The Residential ventilation unit and the Aquarea Heat Pumps can be controlled with one single user-friendly controller.

AQUAREA

Combine the Residential ventilation unit with Panasonic Aquarea for an space saving and highly efficient solution for heating, cooling, ventilation and DHW.



Heat Recovery Ventilation + Aquarea All in One Compact



Heat Recovery Ventilation + DHW Square Tank + Aquarea Mono-bloc



Heat Recovery Ventilation + DHW Square Tank + Aquarea Bi-bloc

* The unit can be mounted on a PAW-TA20C1E5C, on a WH-ADC0309J3E5C or installed on the wall (PAW-VEN-WBRK is needed).

Heat recovery ventilation unit

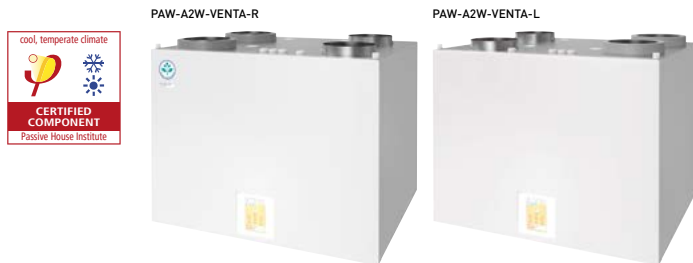

		PAW-A2W-VENTA-R	PAW-A2W-VENTA-L
Nominal air flow rate	m ³ /h	204 @ 50 Pa	
Maximum air flow rate	m ³ /h	292 @ 100 Pa	
SPF		1,24 @ 204 m ³ /h	
Heat exchanger rotor drive type		Variable speed	
Exchanger type		Rotating	
Heat recovery efficiency		84%	
Power supply	V / Hz	230 / 50 / Single phase	
Power consumption	W	176	
Energy class, basic unit		A	
Energy class, unit with local control on demand		A	
Noise level	dB(A)	40	
Dimension (H x W x D)	mm	450 x 598 x 500	
Weight	kg	46	
Mounting position		Vertical	
Supply side		Right	Left
Duct connections	mm	DN125	
Filter class, supply air		F7/ePM1 60%	
Filter class, extract air		M5/ePM10 50%	
Minimum outdoor temperature	°C	-20	

* Heat recovery efficiency according to EN 13141-7. ** Heat recovery ventilation unit is produced by Systemair.

Accessories	
PAW-VEN-FLTKIT	Supply and extract filters kit
PAW-VEN-ACCPCB	Optional PCB for additional functions
PAW-VEN-DPL	HRV touch control panel. White frame (cable must be ordered separately)
PAW-VEN-CBLEXT12	Cable with plug for electrical connection between unit and control panel, type CE and CD (12 m)
PAW-VEN-DIVPLG	Twin plugs for installation of several control panels type CD ou CE for one unit

Accessories	
PAW-VEN-DPLBOX	HRV touch control panel wall-mounted kit
PAW-VEN-S-CO2RH-W	CO ₂ RH wall-mounted sensor
PAW-VEN-S-CO2-W	CO ₂ wall-mounted sensor
PAW-VEN-S-CO2-D	CO ₂ duct sensor
PAW-VEN-WBRK	Wall bracket kit for stand-alone installation on the wall
PAW-VEN-HTR06	Electrical duct heater 0,6 kW (includes relay)
PAW-VEN-HTR12	Electrical duct heater 1,2 kW (includes relay)

Main features of the residential ventilation unit

- Designed for areas up to approximately 140 m²
- High energy-efficiency rotary heat exchanger with EC - technology fans
- Moisture transfer function to minimize condensation in supply air during wintertime
- The built in humidity sensor in extract air can be used for demand control
- Control via touch display and Startup Wizard for easy commissioning
- Modbus communication via RS-485
- Option to control an Aquarea H Series onwards heat pump from PAW-A2W-VENTA control panel (PAW-AW-MBS-H and PAW-VEN-ACCPCB required)

Control user-friendly interface

All settings and features accessible via a control panel, integrated into the front cover. The option for connecting one or more external control panels is available.

- Color touch screen with a user-friendly interface
- MANUAL and AUTO mode or choose preferred settings from the pre-configured user modes
- If Aquarea H and J Series heat pumps are connected with PAW-A2W-VENTA, the heat pump control options appear on the home screen in a separate tab

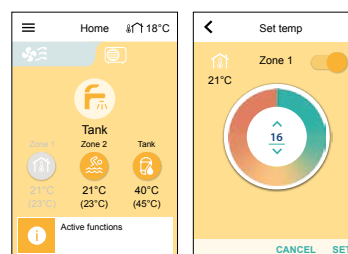
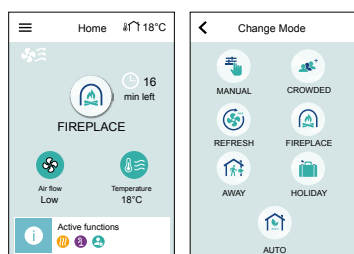

Counter flow ventilation

Controlled mechanical ventilation ensures the supply of fresh air inside a building in order to guarantee a good indoor air quality.



Counter flow ventilation units are equipped with two fans to supply and extract air. A cross-flow heat exchanger recovers the energy contained in the extracted air and transfers it to the supplied air. This significantly reduces the building's energy consumption, while at the same time keeping a good quality of the indoor air.

Balanced ventilation

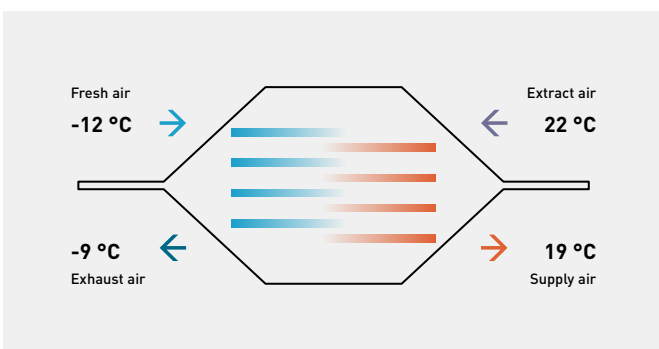

- Suitable for single family houses or apartments with low energy requirements
- High-efficiency sensible heat recovery, thanks to polypropylene counter-flow heat exchanger with large exchange surface and low pressure drop
- High comfort and quiet operation, by using brushless fans with electronic motor and modulating control
- Highly efficient air renewal and filtration, with 80% ePM1 filters
- 3 unit types: compact universal mounting (Z), horizontal mounting (H) and vertical mounting (V)
- Compact dimensions for simplified installation and panel easily accessible for maintenance and inspection

Counter flow ventilation

PAW-VENTX10-15-20-25Z-1

PAW-VENTX20-30-40-50V-1

PAW-VENTX20-30-40-50H-1



PAW-	Air flow		Type of HEX	Recovery efficiency	Energy class	Power supply	Power consumption	Sound power LWA	Dimension	Weight	Mounting position	Filter class	Duct connection
	Nominal / Max	Nominal / Max				Voltage / Phase / Frequency	Nominal		H x W x D				
	m ³ /h	Pa	%			W	dB(A)	mm	kg			mm	
VENTX10Z-1	91/130	50/100	Counter flow HRV	87	A	230 V / Single phase / 50 Hz	80	48	255 x 580 x 580	19	Horizontal / Vertical	ePM1 80%	160
VENTX15Z-1	147/210	50/100	Counter flow HRV	85	A	230 V / Single phase / 50 Hz	140	51	255 x 580 x 580	19	Horizontal / Vertical	ePM1 80%	160
VENTX20Z-1	140/200	50/100	Counter flow HRV	87	A	230 V / Single phase / 50 Hz	120	48	313 x 580 x 580	21	Horizontal / Vertical	ePM1 80%	160
VENTX20H-1	109/155	50/100	Counter flow HRV	86	A	230 V / Single phase / 50 Hz	110	49	270 x 480 x 800	26	Horizontal	ePM1 80%	160
VENTX20V-1	112/170	50/100	Counter flow HRV	86	A	230 V / Single phase / 50 Hz	110	48	510 x 625 x 430	32	Vertical	ePM1 80%	160
VENTX25Z-1	224/320	50/100	Counter flow HRV	85	A	230 V / Single phase / 50 Hz	180	52	313 x 580 x 580	21	Horizontal / Vertical	ePM1 80%	160
VENTX30H-1	210/300	50/100	Counter flow HRV	85	A	230 V / Single phase / 50 Hz	180	50	295 x 795 x 795	31	Horizontal	ePM1 70%	160
VENTX30V-1	210/300	50/100	Counter flow HRV	86	A	230 V / Single phase / 50 Hz	180	50	590 x 785 x 575	38	Vertical	ePM1 70%	160
VENTX40H-1	238/340	50/100	Counter flow HRV	89	A	230 V / Single phase / 50 Hz	350	52	290 x 1150 x 1150	39	Horizontal	ePM1 70%	160
VENTX40V-1	266/380	50/100	Counter flow HRV	87	A	230 V / Single phase / 50 Hz	350	51	590 x 785 x 735	42	Vertical	ePM1 70%	160
VENTX50H-1	288/455	50/100	Counter flow HRV	88	A	230 V / Single phase / 50 Hz	420	56	290 x 1150 x 1150	40	Horizontal	ePM1 70%	160
VENTX50V-1	315/450	50/100	Counter flow HRV	86	A	230 V / Single phase / 50 Hz	420	54	590 x 785 x 735	43	Vertical	ePM1 70%	160

Remote control (sold separately).

Digital remote control with built-in air quality, temperature and humidity sensors (black).
PAW-VEN-CTRLB.



Digital remote control with built-in air quality, temperature and humidity sensors (white).
PAW-VEN-CTRLW.



Accessories

PAW-VEN-HTR05	Electrical duct heater 0,5 kW, DN160 mm
PAW-VEN-HTR10	Electrical duct heater 1,0 kW, DN160 mm
PAW-VEN-FLT1	Spare F7 filter kit (2 pcs) for models 10Z, 15Z, 20H and 20V
PAW-VEN-FLT2	Spare F7 filter kit (2 pcs) for models 30H
PAW-VEN-FLT3	Spare F7 filter kit (2 pcs) for models 40H
PAW-VEN-FLT4	Spare F7 filter kit (2 pcs) for models 40V
PAW-VEN-FLT5	Spare F7 filter kit (2 pcs) for models 30V

Accessories

PAW-VEN-ACFLT1	Activated carbon filter (1 pc) for models 10Z, 15Z, 20H and 20V
PAW-VEN-ACFLT2	Activated carbon filter (1 pc) for models 30H
PAW-VEN-ACFLT3	Activated carbon filter (1 pc) for models 40H
PAW-VEN-ACFLT4	Activated carbon filter (1 pc) for models 40V
PAW-VEN-ACFLT5	Activated carbon filter (1 pc) for models 30V

DHW Stand-alone

The wide range of DHW Stand-alone heat pump is a great solution to adapt to any type of family house.



DHW Stand-alone: highly efficient heat pump water heater.

The wall type is available in 100 and 150 L capacities, and the floor-standing in 200 and 270 L. For reaching even more efficient use the 270 L is available in additional coil, it is able to connect solar water production.

- A+ Highly efficient domestic hot water heat pump
- Provides reduced power consumption up to 72% compared with traditional electric water heater
- Easy to install
- Being CFC-free, this water heater is environmentally friendly

Energy saving

- Digital control panel with energy consumption monitoring
- Photovoltaic function
- Compatible with ducted fresh air intake installations
- Boiler / Solar Coil (only PAW-DHW270C1F)

Comfort

- Different modes of operation based on user needs
- Mode AUTO: Intelligent Temperature Set Point, thanks to monitoring hot water usage
- Mode BOOST, Mode ECO and Mode ABSENCE

Durability

- Diamond-quality enamel lining the inner tank
- Pressure relief valve which provides safety if any malfunctions or pressure rise
- Dielectric union preventing corrosion
- Specific lip gasket preventing rust around the flange

DHW Stand-alone



Type	Wall-mounted			Floor-standing		
	Reference	PAW-DHW100W-1	PAW-DHW150W-1	PAW-DHW200F	PAW-DHW270F	PAW-DHW270C1F
Water volume	L	100	150	200	270	263
Dimension (HxWxD)	mm	1209x522x538	1527x522x538	1617x620x665	1957x620x665	1957x620x665
Empty weight	kg	57	66	80	92	111
Hot and cold connection		¾" M	¾" M	¾" M	¾" M	¾" M
Anticorrosion system	Anode	Magnesium	Magnesium	Magnesium	Magnesium	Magnesium
Rated water pressure	Mpa (bar)	0,8 (8)	0,8 (8)	0,8 (8)	0,8 (8)	0,8 (8)
Electrical connection	V / Hz	230/50	230/50	230/50	230/50	230/50
Total maximum power	W	1550	1950	2300	2300	2300
Maximal power heat pump	W	350	350	700	700	700
Power electric heating element	W	1200	1600	1600	1600	1600
Heat pump water temperature range	°C	50~62	50~62	50~62	50~62	50~62
Heat pump air temperature range	°C	-5~+43	-5~+43	-5~+43	-5~+43	-5~+43
Duct diameter	mm	125	125	160	160	160
Air flow (without duct)	m³/h	160	160	310/390	310/390	310/390
Load losses acceptable on ventilation circuit, without affecting performance	Pa	70	70	25	25	25
Sound power ¹⁾	dB(A)	45	45	53	53	53
Refrigerant R134a (wall-mounted) / R513A (floor-standing)	kg	0,52	0,58	0,80	0,86	0,86
Refrigerant volume in tons of CO ₂ equivalent	TCO ₂ Eq.	0,74	0,83	0,50	0,54	0,54
Refrigerant weight per liter	kg/L	0,0052	0,0039	0,0040	0,0032	0,0032
Hot water quantity at 40 °C: V40td	L	151,0	182,0	265,5	361,2	357,9
Acoustic power ErP ²⁾	dB(A)	45	45	53	53	53
Energy efficiency class (from A+ to F)		A+	A+	A+	A+	A+
Connectable to PV		Yes	Yes	Yes	Yes	Yes
Additional coil exchanger connection		—	—	—	—	1" M
Additional coil surface	m²	—	—	—	—	1,2
Warranty of the inner vessel		5 Years	5 Years	5 Years	5 Years	5 Years
Performance at 7 °C air temperature		(EN 16147) ducted at 25 Pa		(CDC LCIE 103-15/C) ducted at 30 Pa ³⁾		
Coefficient of performance (COP) according load profile		2,66 - M	3,05 - L	2,81 - L	3,16 - XL	3,05 - XL
Standby input power [P _{ss}]	W	18	24	32	29	33
Heating up time [t _h]	h. Min	6h47	10h25	07h11	10h39	11h04
Reference hot water temperature [T _{ref}]	°C	52,7	53,2	52,7	53,1	52,9
Flow rate (air)	m³/h	140	110	320	320	320
Performance at 15 °C air temperature (EN 16147)						
Coefficient of performance (COP) according load profile		2,88 - M	3,28 - L	3,05 - L	3,61 - XL	3,44 - XL
Standby input power [P _{ss}]	W	19	25	30	30	33
Heating up time [t _h]	h. Min	6h07	9h29	6h24	8h34	8h40
Reference hot water temperature [T _{ref}]	°C	52,6	53,4	52,8	53,0	53,1
Flow rate (air)	m³/h	140	110	320	320	320

1) According to ISO3744. 2) Compliant with EN 16147 conditions. 3) Performance measured for a water heater from 10 °C to T_{ref} according to the protocol of the NF Electricity Performance Mark specifications No.LCIE 103-15C, selfheating thermodynamic water heaters (based on standard EN 16147). * DHW Stand-alone is produced by C.I.C.E.

Accessories

PAW-DHW-STAND Rack for suspended device for 100 and 150 liters models

Ideal for small surfaces

Suitable for all installations (adapted to small surfaces, low ceiling, corner).

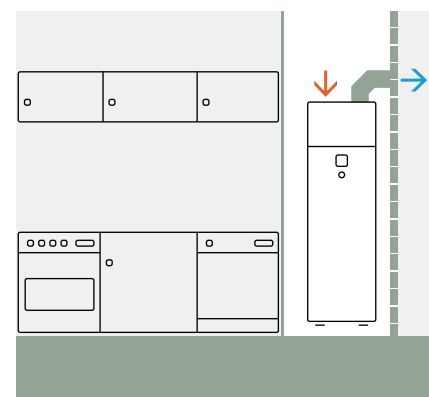
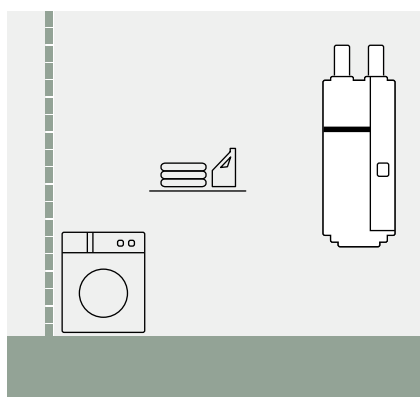

Accessories and control

Controls and room thermostats

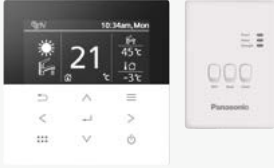

Remote controller with Wi-Fi adapter (required for stand-alone outdoor units). M Series.

CZ-RTW2TAW1C



Optional remote controller for 2 zone control. K and L Series.

CZ-RTW1

Optional remote controller for 2 zone control. M Series.

CZ-RTW2



Cascade manager for Aquarea Heat Pumps.

PAW-A2W-CMH-2



Wired LCD room thermostat with weekly timer.

PAW-A2W-RTWIRED



Wireless LCD room thermostat with weekly timer.

PAW-A2W-RTWIRELESS

PCBs for additional functions

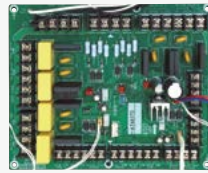

PCB for advanced functions. J and H Series.

CZ-NS4P

PCB for advanced functions. K and L Series.

CZ-NS5P

PCB for advanced functions. M Series All in One and Bi-bloc.

CZ-NS6P

PCB for advanced functions. M Series control module.

CZ-NS7P

Outdoor unit accessories



Base pan heater for Bi-bloc 3 and 5 kW (except L Series) and K Series 7 and 9 kW (1 fan model).

CZ-NE2P

Base pan heater. J and H Series and K Series 9 (2 fans model), 12 and 16 kW.

CZ-NE3P

Base pan heater. L Series 5, 7 and 9 kW and M Series.

CZ-NE4P



Black ground stand for outdoor unit with 940 mm wide condenser water tray.

PAW-GRDSTD940



Black ground stand for outdoor unit with 1100 mm wide condenser water tray.

PAW-GRDSTD1100

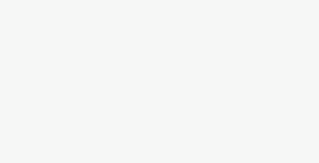

Electrical heater foil for the ground stand with 940 mm wide condenser water tray.



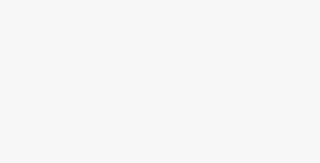

PAW-GRDSTDHTR940

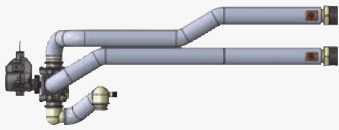

Electrical heater foil for the ground stand with 1100 mm wide condenser water tray.

PAW-GRDSTDHTR1100





Hydraulic accessories

 <p>3 way valve kit to fit inside the hydrokit. J and H Series.</p> <p>-----</p> <p>CZ-NV1</p> <p>3 way valve kit to fit inside the hydrokit. K and L Series.</p> <p>-----</p> <p>CZ-NV2</p>	 <p>3 way valve for DHW tanks.</p> <p>-----</p> <p>PAW-3WYVLV-HW</p>	 <p>1 antifreeze valve. It is required to order 2 valves per system.</p> <p>-----</p> <p>PAW-A2W-AFVLV-1</p>	 <p>Optional magnet for the water filter in H Series models.</p> <p>-----</p> <p>PAW-A2W-MGTFILTER</p>
---------------------------------------------------------------------------------------------------------------------------------------------------------------------------------------------------------------------------------------------------------------------------------------------	--------------------------------------------------------------------------------------------------------------------------------------------------------------	-----------------------------------------------------------------------------------------------------------------------------------------------------------------------------------------------------------	--------------------------------------------------------------------------------------------------------------------------------------------------------------------------------------------------

Connectivity

 <p>Aquarea Smart Cloud for remote control and maintenance through wireless or wired LAN.</p> <p>-----</p> <p>CZ-TAW1B</p> <p>10 m extension cable for CZ-TAW1B.</p> <p>-----</p> <p>CZ-TAW1-CBL</p>	 <p>External meter gateway for K Series onwards.</p> <p>-----</p> <p>PAW-A2W-EXTMETER</p>	 <p>KNX interface for H Series onwards (Intesis).</p> <p>-----</p> <p>PAW-AW-KNX-H</p>
 <p>Modbus interface for H Series onwards (Intesis).</p> <p>-----</p> <p>PAW-AW-MBS-H</p>	 <p>KNX interface for H Series onwards (Airzone).</p> <p>-----</p> <p>PAW-AZAW-KNX-1</p>	 <p>Modbus interface for H Series onwards (Airzone).</p> <p>-----</p> <p>PAW-AZAW-MBS-1</p>











Sensors for Aquarea H Series onwards

 <p>Outdoor ambient sensor.</p> <p>-----</p> <p>PAW-A2W-TS0D</p>	 <p>Zone room sensor.</p> <p>-----</p> <p>PAW-A2W-TSRT</p>	 <p>Zone water sensor.</p> <p>-----</p> <p>PAW-A2W-TSHC</p>
 <p>Solar sensor.</p> <p>-----</p> <p>PAW-A2W-TSS0</p>	 <p>Buffer tank sensor (PAW-A2W-TSHC required if optional PCB is used).</p> <p>-----</p> <p>PAW-A2W-TSBU</p>	

Smart fan coil accessories



<p>Set of 2 legs to protect water pipes. ----- PAW-AAIR-LEGS-1</p>	<p>Motor connection cable for units with right hand hydraulic connections. ----- PAW-AAIR-RHCABLE</p>
-----------------------------------------------------------------------------------	----------------------------------------------------------------------------------------------------------------------

Fan coil units controllers





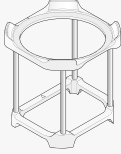





 <p>Electro-mechanical controller (supplied loose). ----- TRM-FA</p>	 <p>Electronic controller. ----- Plogic</p>	 <p>Electronic controller. ----- TControl EASY 3S</p>	 <p>Electronic controller. ----- TControl POD glass</p>
 <p>Wired remote controller with touch control for 2-pipe and 4-pipe, EC fan coil (control + Modbus). ----- PAW-FC-907EC</p> <p>Wired remote controller with touch control for 2-pipe, AC fan coil (control only). ----- PAW-FC-907AC</p>	 <p>Wired remote controller for 2-pipe and 4-pipe, EC fan coil (control + Modbus). ----- PAW-FC-903EC</p> <p>Wired remote controller for 2-pipe, AC fan coil (control only). ----- PAW-FC-903AC</p>	 <p>Advanced wired remote controller for fan coil. ----- PAW-FC-RC1</p>	 <p>Smart controller. Mini building management system. ----- SRC</p>
 <p>Plogic remote control. ----- WRC / MRC</p>	 <p>Plogic remote control. ----- BRC</p>	 <p>Plogic remote control. ----- IRC</p>	

Sanitary tank accessories



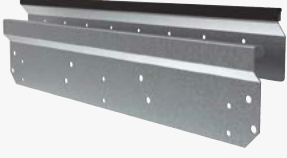

DHW Stand-alone accessories

<p>Tank sensor with 5 m cable length. ----- PAW-TS1</p>	 <p>Tank sensor with 20 m cable length. ----- PAW-TS2</p>	<p>Tank sensor with 5 m cable length and only 6 mm diameter. ----- PAW-TS4</p>	 <p>Stand for wall-mounted models (required for installation in non-load-bearing walls). ----- PAW-DHW-STAND</p>
 <p>Temperature sensor kit for third party tank (with copper pocket and 20 m length sensor cable). ----- CZ-TK1</p>	<p>Impressed current anode for 200 L Stainless steel tanks. ----- PAW-EANODE2</p>	 <p>Impressed current anode for 300 L Stainless steel tanks. ----- PAW-EANODE3</p>	

Heat recovery ventilation accessories

 <p>Supply and extract filters kit.</p> <p>-----</p> <p>PAW-VEN-FLTKIT</p>	 <p>Optional PCB for additional functions.</p> <p>-----</p> <p>PAW-VEN-ACPCB</p>	 <p>HRV touch control panel. White frame (cable must be ordered separately).</p> <p>-----</p> <p>PAW-VEN-DPL</p>	 <p>Cable with plug for electrical connection between unit and control panel, type CE and CD (12 m).</p> <p>-----</p> <p>PAW-VEN-CBLEXT12</p>
 <p>Twin plugs for installation of several control panels type CD or CE for one unit.</p> <p>-----</p> <p>PAW-VEN-DIVPLG</p>	 <p>HRV touch control panel wall-mounted kit.</p> <p>-----</p> <p>PAW-VEN-DPLBOX</p>	 <p>CO₂ RH wall-mounted sensor.</p> <p>-----</p> <p>PAW-VEN-S-C02RH-W</p>	 <p>CO₂ wall-mounted sensor.</p> <p>-----</p> <p>PAW-VEN-S-C02-W</p>
 <p>CO₂ duct sensor.</p> <p>-----</p> <p>PAW-VEN-S-C02-D</p>	 <p>Wall bracket kit for stand-alone installation on the wall.</p> <p>-----</p> <p>PAW-VEN-WBRK</p>	 <p>Electrical duct heater 0,6 kW (includes relay).</p> <p>-----</p> <p>PAW-VEN-HTR06</p>	 <p>Electrical duct heater 1,2 kW (includes relay).</p> <p>-----</p> <p>PAW-VEN-HTR12</p>

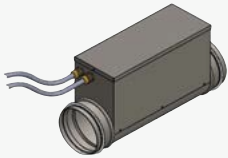
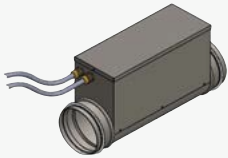
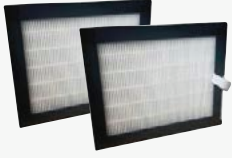
Counter flow ventilation accessories

 <p>Digital remote control (black). Integrated air quality, temperature and humidity sensors.</p> <p>-----</p> <p>PAW-VEN-CTRLB</p>	 <p>Digital remote control (white). Integrated air quality, temperature and humidity sensors.</p> <p>-----</p> <p>PAW-VEN-CTRLW</p>	 <p>Electrical duct heater 0,5 kW, DN160 mm.</p> <p>-----</p> <p>PAW-VEN-HTR05</p>	 <p>Electrical duct heater 1,0 kW, DN160 mm.</p> <p>-----</p> <p>PAW-VEN-HTR10</p>
 <p>Spare F7 filter kit (2 pcs) for models 10Z, 15Z, 20H and 20V.</p> <p>-----</p> <p>PAW-VEN-FLT1</p> <p>Spare F7 filter kit (2 pcs) for models 30H.</p> <p>-----</p> <p>PAW-VEN-FLT2</p> <p>Spare F7 filter kit (2 pcs) for models 40H.</p> <p>-----</p> <p>PAW-VEN-FLT3</p> <p>Spare F7 filter kit (2 pcs) for models 40V.</p> <p>-----</p> <p>PAW-VEN-FLT4</p> <p>Spare F7 filter kit (2 pcs) for models 30V.</p> <p>-----</p> <p>PAW-VEN-FLT5</p>	 <p>Activated carbon filter (1 pc) for models 10Z, 15Z, 20H and 20V.</p> <p>-----</p> <p>PAW-VEN-ACFLT1</p> <p>Activated carbon filter (1 pc) for models 30H.</p> <p>-----</p> <p>PAW-VEN-ACFLT2</p> <p>Activated carbon filter (1 pc) for models 40H.</p> <p>-----</p> <p>PAW-VEN-ACFLT3</p> <p>Activated carbon filter (1 pc) for models 40V.</p> <p>-----</p> <p>PAW-VEN-ACFLT4</p> <p>Activated carbon filter (1 pc) for models 30V.</p> <p>-----</p> <p>PAW-VEN-ACFLT5</p>		

Heating and cooling capacity tables

Based on outlet temperature and outside temperature.

Aquarea High Performance Hydraulic All in One L Series Single phase. Heating and Cooling · R290

WH-WDG05LE5

Tamb	HC	IP	COP	HC	IP	COP	HC	IP	COP	HC	IP	COP	HC	IP	COP
LWC	35	35	35	45	45	45	55	55	55	65	65	65	75	75	75
-25	2,45	1,76	1,39	3,80	2,30	1,65	3,60	2,46	1,46	—	—	—	—	—	—
-20	4,70	2,19	2,15	4,50	2,37	1,90	4,25	2,57	1,65	—	—	—	—	—	—
-15	5,00	1,94	2,58	5,00	2,31	2,16	5,00	2,63	1,90	4,60	2,88	1,60	—	—	—
-7	5,00	1,66	3,01	5,00	1,94	2,58	5,00	2,36	2,12	5,00	2,62	1,91	4,30	2,87	1,50
2	5,00	1,42	3,52	5,00	1,71	2,92	5,00	2,14	2,34	5,00	2,54	1,97	4,60	2,76	1,67
7	5,00	0,99	5,05	5,00	1,27	3,94	5,00	1,63	3,07	5,00	2,03	2,46	4,70	2,57	1,83

WH-WDG07LE5

Tamb	HC	IP	COP	HC	IP	COP	HC	IP	COP	HC	IP	COP	HC	IP	COP
LWC	35	35	35	45	45	45	55	55	55	65	65	65	75	75	75
-25	4,75	2,53	1,88	4,30	2,66	1,62	3,95	2,78	1,42	—	—	—	—	—	—
-20	5,50	2,56	2,15	5,10	2,75	1,85	4,90	2,97	1,65	—	—	—	—	—	—
-15	6,00	2,50	2,40	5,50	2,60	2,12	5,20	2,89	1,80	4,80	3,00	1,60	—	—	—
-7	5,80	1,93	3,01	5,80	2,32	2,50	5,80	2,74	2,12	5,70	3,16	1,80	4,80	3,56	1,35
2	6,85	2,00	3,43	6,60	2,34	2,82	6,25	2,67	2,34	5,60	2,80	2,00	5,00	3,13	1,60
7	7,00	1,42	4,93	7,00	1,90	3,68	7,00	2,35	2,98	6,60	2,85	2,32	6,30	3,40	1,85

WH-WDG09LE5

Tamb	HC	IP	COP	HC	IP	COP	HC	IP	COP	HC	IP	COP	HC	IP	COP
LWC	35	35	35	45	45	45	55	55	55	65	65	65	75	75	75
-25	6,05	3,43	1,76	5,25	3,28	1,60	4,65	3,15	1,48	—	—	—	—	—	—
-20	7,00	3,56	1,97	6,20	3,50	1,77	5,60	3,43	1,63	—	—	—	—	—	—
-15	7,40	3,20	2,31	6,80	3,40	2,00	6,30	3,55	1,77	5,60	3,55	1,58	—	—	—
-7	7,00	2,50	2,80	7,00	2,98	2,35	7,00	3,29	2,13	6,50	3,53	1,84	5,40	3,56	1,52
2	7,00	2,05	3,41	7,00	2,50	2,80	7,00	2,90	2,41	6,70	3,35	2,00	5,70	3,40	1,68
7	9,00	1,98	4,55	9,00	2,58	3,49	8,90	2,94	3,03	8,90	3,56	2,50	7,30	3,56	2,05

Aquarea High Performance Hydraulic All in One L Series Single phase. Heating and Cooling · R290

WH-WDG05LE5

Tamb	CC	IP	EER	CC	IP	EER	CC	IP	EER
LWC	7	7	7	14	14	14	18	18	18
16	6,00	1,01	5,94	7,50	1,05	7,14	6,00	0,67	8,96
25	5,70	1,20	4,75	7,00	1,20	5,83	5,70	0,78	7,31
35	5,00	1,55	3,23	6,30	1,44	4,38	5,00	1,00	5,00
43	4,50	1,60	2,81	5,60	1,64	3,41	4,50	1,12	4,02

WH-WDG07LE5

Tamb	CC	IP	EER	CC	IP	EER	CC	IP	EER
LWC	7	7	7	14	14	14	18	18	18
16	7,00	1,36	5,15	8,50	1,39	6,12	8,00	1,04	7,69
25	7,00	1,65	4,24	8,00	1,57	5,10	7,50	1,18	6,36
35	7,00	2,31	3,03	8,00	2,26	3,54	7,00	1,48	4,73
43	6,00	2,50	2,40	7,00	2,60	2,69	5,70	1,70	3,35

WH-WDG09LE5

Tamb	CC	IP	EER	CC	IP	EER	CC	IP	EER
LWC	7	7	7	14	14	14	18	18	18
16	9,00	2,00	4,50	11,00	2,12	5,19	11,00	1,80	6,11
25	9,00	2,50	3,60	11,00	2,60	4,23	10,00	1,85	5,41
35	8,20	2,91	2,82	10,00	3,10	3,23	9,00	2,15	4,19
43	6,40	2,67	2,40	7,40	2,70	2,74	8,20	2,50	3,28

Tamb: Ambient Temperature [°C]. LWC: Leaving Water Condenser Temperature [°C]. HC: Heating Capacity (kW). CC: Cooling Capacity (kW). IP: Input Power (kW). This data is measured by Panasonic in accordance with EN14511-2 standard. This data is for reference purpose only, and does not guarantee the performance.

Aquarea High Performance Mono-bloc J Series Single phase. Heating and Cooling - MDC - R32

WH-MDC05J3E5

Tamb	HC	IP	COP	HC	IP	COP	HC	IP	COP	HC	IP	COP	HC	IP	COP
LWC	25	25	25	35	35	35	45	45	45	55	55	55	60	60	60
-20	4,37	1,73	2,53	4,16	2,03	2,05	3,84	2,37	1,62	3,43	2,64	1,30	—	—	—
-15	5,13	1,78	2,88	5,00	2,17	2,30	4,75	2,51	1,89	3,70	2,45	1,51	—	—	—
-7	5,17	1,49	3,47	5,00	1,80	2,78	4,80	2,16	2,22	5,00	2,70	1,85	4,68	2,71	1,73
2	5,00	1,11	4,50	5,00	1,40	3,57	5,00	1,81	2,76	5,00	2,20	2,27	4,80	2,40	2,00
7	5,09	0,78	6,53	5,00	0,99	5,05	5,00	1,31	3,82	5,00	1,66	3,01	4,58	1,90	2,41
25	4,96	0,77	6,44	5,04	0,90	5,60	5,31	1,16	4,58	5,61	1,34	4,19	5,15	1,33	3,87

WH-MDC07J3E5

Tamb	HC	IP	COP	HC	IP	COP	HC	IP	COP	HC	IP	COP	HC	IP	COP
LWC	25	25	25	35	35	35	45	45	45	55	55	55	60	60	60
-20	4,86	2,03	2,39	4,66	2,35	1,98	4,44	2,75	1,61	4,23	3,13	1,35	—	—	—
-15	5,80	2,11	2,75	5,60	2,40	2,33	5,30	2,84	1,87	5,00	3,32	1,51	—	—	—
-7	6,76	2,07	3,27	6,80	2,42	2,81	6,30	2,82	2,23	6,30	3,39	1,86	4,74	2,76	1,72
2	6,83	1,66	4,11	7,00	2,06	3,40	6,85	2,50	2,74	6,30	2,92	2,16	4,80	2,40	2,00
7	7,32	1,19	6,15	7,00	1,47	4,76	7,00	1,96	3,57	7,00	2,48	2,82	6,18	2,44	2,53
25	6,80	0,64	10,63	6,67	0,93	7,17	6,79	1,38	4,92	6,70	1,80	3,72	6,22	1,78	3,49

WH-MDC09J3E5

Tamb	HC	IP	COP	HC	IP	COP	HC	IP	COP	HC	IP	COP	HC	IP	COP
LWC	25	25	25	35	35	35	45	45	45	55	55	55	60	60	60
-20	5,33	2,36	2,26	6,43	3,60	1,79	5,78	3,83	1,51	4,83	3,64	1,33	—	—	—
-15	7,76	3,20	2,43	7,60	3,41	2,23	7,00	3,71	1,89	5,60	3,80	1,47	—	—	—
-7	7,39	2,45	3,02	7,50	2,85	2,63	7,30	3,37	2,17	7,00	3,89	1,80	6,44	3,67	1,75
2	7,38	1,89	3,90	7,45	2,38	3,13	7,00	2,85	2,46	7,00	3,30	2,12	5,46	2,72	2,01
7	9,15	1,59	5,75	9,00	2,01	4,48	9,00	2,61	3,45	8,95	3,22	2,78	7,25	2,87	2,53
25	8,02	0,98	8,18	7,88	1,32	5,97	8,46	1,86	4,55	7,60	2,03	3,74	6,30	1,87	3,37

Aquarea High Performance Mono-bloc J Series Single phase. Heating and Cooling - MDC - R32

WH-MDC05J3E5

Tamb	CC	IP	EER	CC	IP	EER	CC	IP	EER
LWC	7	7	7	14	14	14	18	18	18
16	5,18	0,82	6,32	6,17	0,84	7,35	5,78	0,60	9,63
25	5,38	1,22	4,41	6,64	1,25	5,31	5,55	0,78	7,12
35	5,00	1,54	3,25	5,86	1,61	3,64	5,00	0,99	5,05
43	4,19	1,85	2,26	5,36	1,92	2,79	4,37	1,30	3,36

WH-MDC07J3E5

Tamb	CC	IP	EER	CC	IP	EER	CC	IP	EER
LWC	7	7	7	14	14	14	18	18	18
16	5,38	0,83	6,48	6,69	0,85	7,87	7,65	0,76	10,07
25	6,96	1,82	3,82	9,06	1,98	4,58	7,58	1,23	6,16
35	7,00	2,29	3,06	8,37	2,47	3,39	7,00	1,48	4,73
43	5,60	2,55	2,20	6,87	2,58	2,66	6,10	1,88	3,24

WH-MDC09J3E5

Tamb	CC	IP	EER	CC	IP	EER	CC	IP	EER
LWC	7	7	7	14	14	14	18	18	18
16	6,89	1,21	5,69	8,65	1,23	7,03	9,82	1,19	8,25
25	9,50	2,84	3,35	11,55	3,06	3,77	9,68	1,82	5,32
35	9,00	3,32	2,71	10,10	3,51	2,88	9,00	2,12	4,25
43	5,42	2,56	2,12	6,56	2,56	2,56	7,40	2,56	2,89

Tamb: Ambient Temperature [°C]. LWC: Leaving Water Condenser Temperature [°C]. HC: Heating Capacity [kW]. CC: Cooling Capacity [kW]. IP: Input Power [kW]. This data is measured by Panasonic in accordance with EN14511-2 standard. This data is for reference purpose only, and does not guarantee the performance.

Heating and cooling capacity tables

Based on outlet temperature and outside temperature.

Aquarea High Performance Mono-bloc H Series Single phase. Heating and Cooling - MDC - R410A

WH-MDC12H6E5

Tamb	HC	IP	COP	HC	IP	COP	HC	IP	COP	HC	IP	COP	HC	IP	COP	HC	IP	COP
LWC	30	30	30	35	35	35	40	40	40	45	45	45	50	50	50	55	55	55
-15	9,30	3,46	2,69	8,90	3,62	2,46	8,50	3,79	2,24	8,10	3,95	2,05	—	—	—	7,00	4,10	1,71
-7	10,40	3,37	3,09	10,00	3,66	2,73	9,60	3,95	2,43	9,20	4,24	2,17	—	—	—	8,20	4,21	1,95
2	11,80	3,10	3,81	11,40	3,31	3,44	11,00	3,53	3,12	10,60	3,74	2,83	—	—	—	9,10	4,08	2,23
7	12,00	2,10	5,71	12,00	2,53	4,74	12,00	2,96	4,05	12,00	3,39	3,54	—	—	—	12,00	4,10	2,93
12	12,00	1,38	8,70	12,00	1,66	7,23	11,80	1,94	6,08	11,70	2,23	5,25	—	—	—	11,40	2,74	4,16

WH-MDC16H6E5

Tamb	HC	IP	COP	HC	IP	COP	HC	IP	COP	HC	IP	COP	HC	IP	COP	HC	IP	COP
LWC	30	30	30	35	35	35	40	40	40	45	45	45	50	50	50	55	55	55
-15	10,60	4,09	2,59	10,30	4,38	2,35	10,00	4,67	2,14	9,70	4,96	1,96	7,90	4,84	1,63	—	—	—
-7	11,90	4,03	2,95	11,40	4,43	2,57	10,80	4,83	2,24	10,30	5,22	1,97	9,00	4,88	1,84	—	—	—
2	13,50	13,74	0,98	13,00	3,96	3,28	12,40	4,18	2,97	11,90	4,40	2,70	9,80	4,44	2,21	—	—	—
7	16,00	3,21	4,98	16,00	3,74	4,28	16,00	4,27	3,75	16,00	4,80	3,33	14,50	5,33	2,72	—	—	—
12	16,00	2,31	6,93	16,00	2,69	5,95	16,00	3,07	5,21	16,00	3,45	4,64	15,90	3,89	4,09	—	—	—

Aquarea High Performance Mono-bloc H Series Single phase. Heating and Cooling - MDC - R410A

WH-MDC12H6E5

Tamb	CC	IP	EER	CC	IP	EER	CC	IP	EER
LWC	7	7	7	14	14	14	18	18	18
16	7,86	1,18	6,66	13,15	2,05	6,41	10,00	1,73	5,78
25	12,08	2,90	4,17	15,70	3,05	5,15	10,00	1,97	5,08
35	10,00	3,56	2,81	12,00	3,67	3,27	10,00	2,15	4,65
43	7,80	3,80	2,05	11,10	3,19	3,48	8,00	2,85	2,81

WH-MDC16H6E5

Tamb	CC	IP	EER	CC	IP	EER	CC	IP	EER
LWC	7	7	7	14	14	14	18	18	18
16	9,20	1,62	5,68	16,40	2,58	6,36	12,20	2,45	4,98
25	14,40	3,92	3,67	19,20	3,83	5,01	12,20	2,79	4,37
35	12,20	4,76	2,56	15,00	4,98	3,01	12,20	2,96	4,12
43	7,75	3,40	2,28	13,80	5,95	2,32	9,70	4,00	2,43

Aquarea T-CAP Mono-bloc J Series Single phase / Three phase. Heating and Cooling - MXC · R32

WH-MXC09J3E5																
Tamb	HC	IP	COP	HC	IP	COP	HC	IP	COP	HC	IP	COP	HC	IP	COP	HC
LWC	25	25	25	35	35	35	45	45	45	55	55	55	60	60	60	60
-20	9,00	3,44	2,62	9,00	3,95	2,28	9,00	4,65	1,94	7,90	5,58	1,42	—	—	—	—
-15	9,00	2,98	3,02	9,00	3,41	2,64	9,00	4,04	2,23	9,00	4,83	1,86	8,70	5,37	1,62	1,62
-7	10,50	2,72	3,86	9,00	2,92	3,08	9,00	3,54	2,54	9,00	4,24	2,12	9,00	4,62	1,95	1,95
2	10,80	2,14	5,05	9,00	2,36	3,81	9,00	2,91	3,09	9,00	3,55	2,54	9,00	4,05	2,22	2,22
7	9,00	1,38	6,52	9,00	1,77	5,08	9,00	2,37	3,80	9,00	2,92	3,08	9,00	3,29	2,74	2,74
25	9,00	0,77	11,69	9,00	1,00	9,00	10,00	1,67	5,99	10,00	2,28	4,39	11,00	2,86	3,85	3,85
WH-MXC12J6E5																
Tamb	HC	IP	COP	HC	IP	COP	HC	IP	COP	HC	IP	COP	HC	IP	COP	HC
LWC	25	25	25	35	35	35	45	45	45	55	55	55	60	60	60	60
-20	12,00	5,02	2,39	12,00	5,80	2,07	11,00	5,95	1,85	10,00	6,50	1,54	—	—	—	—
-15	12,00	4,14	2,90	12,00	4,83	2,48	11,00	5,20	2,12	10,50	6,00	1,75	8,90	6,30	1,41	1,41
-7	13,50	4,30	3,14	12,00	4,25	2,82	12,00	5,02	2,39	12,00	6,00	2,00	11,00	6,30	1,75	1,75
2	14,50	3,23	4,49	12,00	3,40	3,53	12,00	4,20	2,86	12,00	4,95	2,42	12,00	5,77	2,08	2,08
7	12,00	2,00	6,00	12,00	2,50	4,80	12,00	3,24	3,70	12,00	3,94	3,05	12,00	4,52	2,65	2,65
25	12,00	1,20	10,00	12,00	1,49	8,05	12,00	2,10	5,71	12,00	2,75	4,36	12,00	3,11	3,86	3,86
WH-MXC09J3E8																
Tamb	HC	IP	COP	HC	IP	COP	HC	IP	COP	HC	IP	COP	HC	IP	COP	HC
LWC	25	25	25	35	35	35	45	45	45	55	55	55	60	60	60	60
-20	9,00	3,44	2,62	9,00	3,95	2,28	9,00	4,65	1,94	7,90	5,58	1,42	—	—	—	—
-15	9,00	2,98	3,02	9,00	3,41	2,64	9,00	4,04	2,23	9,00	4,83	1,86	8,70	5,37	1,62	1,62
-7	10,50	2,72	3,86	9,00	2,92	3,08	9,00	3,54	2,54	9,00	4,24	2,12	9,00	4,62	1,95	1,95
2	10,80	2,14	5,05	9,00	2,36	3,81	9,00	2,91	3,09	9,00	3,55	2,54	9,00	4,05	2,22	2,22
7	9,00	1,38	6,52	9,00	1,77	5,08	9,00	2,37	3,80	9,00	2,92	3,08	9,00	3,29	2,74	2,74
25	9,00	0,77	11,69	9,00	1,00	9,00	10,00	1,67	5,99	10,00	2,28	4,39	11,00	2,86	3,85	3,85
WH-MXC12J9E8																
Tamb	HC	IP	COP	HC	IP	COP	HC	IP	COP	HC	IP	COP	HC	IP	COP	HC
LWC	25	25	25	35	35	35	45	45	45	55	55	55	60	60	60	60
-20	12,00	5,02	2,39	12,00	5,80	2,07	10,50	5,75	1,83	9,20	5,80	1,59	—	—	—	—
-15	12,00	4,14	2,90	12,00	4,83	2,48	12,00	5,67	2,12	11,10	6,35	1,75	8,70	6,20	1,40	1,40
-7	13,50	4,30	3,14	12,00	4,25	2,82	12,00	5,02	2,39	12,00	6,00	2,00	11,00	6,30	1,75	1,75
2	14,50	3,23	4,49	12,00	3,40	3,53	12,00	4,20	2,86	12,00	4,95	2,42	12,00	5,77	2,08	2,08
7	12,00	2,00	6,00	12,00	2,50	4,80	12,00	3,24	3,70	12,00	3,94	3,05	12,00	4,52	2,65	2,65
25	12,00	1,20	10,00	12,00	1,49	8,05	12,00	2,10	5,71	12,00	2,75	4,36	12,00	3,11	3,86	3,86
WH-MXC16J9E8																
Tamb	HC	IP	COP	HC	IP	COP	HC	IP	COP	HC	IP	COP	HC	IP	COP	HC
LWC	25	25	25	35	35	35	45	45	45	55	55	55	60	60	60	60
-20	16,00	7,40	2,16	16,00	8,40	1,90	16,00	10,00	1,60	14,00	10,30	1,36	—	—	—	—
-15	15,30	6,10	2,51	16,00	6,91	2,32	16,00	8,44	1,90	16,00	9,97	1,60	14,00	10,60	1,32	1,32
-7	19,00	6,60	2,88	16,00	6,70	2,39	16,00	7,85	2,04	16,00	9,33	1,71	15,00	9,70	1,55	1,55
2	20,60	5,35	3,85	16,00	5,16	3,10	16,00	6,40	2,50	16,00	7,72	2,07	16,00	9,20	1,74	1,74
7	16,00	2,80	5,71	16,00	3,54	4,52	16,00	4,55	3,52	16,00	5,60	2,86	15,60	6,50	2,40	2,40
25	16,00	1,55	10,32	16,00	2,30	6,96	16,00	3,20	5,00	16,00	4,00	4,00	15,50	4,50	3,44	3,44

Aquarea T-CAP Mono-bloc J Series Single phase / Three phase. Heating and Cooling - MXC · R32

Outdoor WH-MXC09J3E5										WH-MXC12J6E5								
Tamb	CC	IP	EER	CC	IP	EER	CC	IP	EER	CC	IP	EER	CC	IP	EER	CC	IP	EER
LWC	7	7	7	14	14	14	18	18	18	7	7	7	14	14	14	18	18	18
16	9,00	1,61	5,59	11,00	1,49	7,38	11,40	1,30	8,77	11,40	2,10	5,43	13,60	2,09	6,51	15,00	2,06	7,28
25	9,00	2,00	4,50	12,60	2,38	5,29	10,50	1,54	6,82	12,00	2,87	4,18	15,70	3,60	4,36	14,00	2,56	5,47
35	9,00	2,83	3,18	10,90	2,98	3,66	9,00	1,95	4,62	12,00	4,14	2,90	13,60	4,35	3,13	12,00	3,04	3,95
43	7,20	3,26	2,21	8,70	3,23	2,69	7,30	2,43	3,00	10,30	4,89	2,11	11,80	4,98	2,37	10,40	3,72	2,80
Outdoor WH-MXC09J3E8										WH-MXC12J9E8								
Tamb	CC	IP	EER	CC	IP	EER	CC	IP	EER	CC	IP	EER	CC	IP	EER	CC	IP	EER
LWC	7	7	7	14	14	14	18	18	18	7	7	7	14	14	14	18	18	18
16	9,00	1,66	5,42	11,00	1,54	7,14	11,40	1,35	8,44	11,40	2,15	5,30	13,60	2,14	6,36	15,00	2,15	6,98
25	9,00	2,06	4,37	12,60	2,45	5,14	10,50	1,60	6,56	12,00	2,93	4,10	15,70	3,68	4,27	14,00	2,66	5,26
35	9,00	2,91	3,09	10,90	3,07	3,55	9,00	2,02	4,46	12,00	4,23	2,84	13,60	4,44	3,06	12,00	3,17	3,79
43	7,20	3,36	2,14	8,70	3,33	2,61	7,30	2,53	2,89	10,30	5,00	2,06	11,80	5,09	2,32	10,40	3,87	2,69
Outdoor WH-MXC16J9E8										WH-MXC16J9E8								
Tamb	CC	IP	EER	CC	IP	EER	CC	IP	EER	CC	IP	EER	CC	IP	EER	CC	IP	EER
LWC	7	7	7	14	14	14	18	18	18	7	7	7	14	14	14	18	18	18
16	9,00	1,66	5,42	11,00	1,54	7,14	11,40	1,35	8,44	11,40	2,15	5,30	13,60	2,14	6,36	15,00	2,15	6,98
25	9,00	2,06	4,37	12,60	2,45	5,14	10,50	1,60	6,56	12,00	2,93	4,10	15,70	3,68	4,27	14,00	2,66	5,26
35	9,00	2,91	3,09	10,90	3,07	3,55	9,00	2,02	4,46	12,00	4,23	2,84	13,60	4,44	3,06	12,00	3,17	3,79
43	7,20	3,36	2,14	8,70	3,33	2,61	7,30	2,53	2,89	10,30	5,00	2,06	11,80	5,09	2,32	10,40	3,87	2,69

Tamb: Ambient Temperature (°C). LWC: Leaving Water Condenser Temperature (°C). HC: Heating Capacity (kW). CC: Cooling Capacity (kW). IP: Input Power (kW). This data is measured by Panasonic in accordance with EN14511-2 standard. This data is for reference purpose only, and does not guarantee the performance.

Heating and cooling capacity tables

Based on outlet temperature and outside temperature.

Aquarea EcoFlex. Single phase. Heating and Cooling · R32

CU-2WZ71YBE5

Tamb	HC	IP	COP	HC	IP	COP	HC	IP	COP	HC	IP	COP
LWC	25	25	25	35	35	35	45	45	45	55	55	55
-15	4,85	2,15	2,26	4,75	2,28	2,08	4,65	2,44	1,91	4,50	3,20	1,41
-7	5,40	1,70	3,18	5,60	1,97	2,84	5,60	2,40	2,33	5,30	2,78	1,91
2	6,50	1,77	3,67	6,70	2,06	3,25	6,60	2,45	2,69	6,00	2,89	2,08
7	8,16	1,63	5,01	8,00	1,90	4,21	8,00	2,30	3,48	8,00	2,85	2,81
12	8,22	1,28	6,42	8,00	1,52	5,26	8,00	2,00	4,00	8,00	2,60	3,08

Aquarea High Performance Bi-bloc K Series Single phase. Heating and Cooling · R32

WH-UDZ03KE5

Tamb	HC	IP	COP	HC	IP	COP	HC	IP	COP	HC	IP	COP	HC	IP	COP
LWC	25	25	25	35	35	35	45	45	45	55	55	55	60	60	60
-20	2,50	1,11	2,25	2,52	1,31	1,92	2,24	1,59	1,41	2,12	1,80	1,18	—	—	—
-15	3,00	1,14	2,63	3,20	1,37	2,34	3,00	1,62	1,85	2,75	1,92	1,43	—	—	—
-7	2,99	0,91	3,29	3,30	1,18	2,80	3,25	1,47	2,21	3,20	1,79	1,79	3,00	1,88	1,60
2	2,92	0,69	4,23	3,20	0,88	3,64	3,20	1,13	2,83	3,20	1,46	2,19	3,15	1,67	1,89
7	3,09	0,49	6,31	3,20	0,60	5,33	3,20	0,84	3,81	3,20	1,14	2,81	2,95	1,22	2,42

WH-UDZ05KE5

Tamb	HC	IP	COP	HC	IP	COP	HC	IP	COP	HC	IP	COP	HC	IP	COP
LWC	25	25	25	35	35	35	45	45	45	55	55	55	60	60	60
-20	—	—	—	4,05	1,95	2,08	3,76	2,20	1,71	3,39	2,48	1,37	—	—	—
-15	—	—	—	5,00	2,11	2,37	4,75	2,49	1,91	4,30	2,61	1,65	—	—	—
-7	—	—	—	5,00	1,79	2,79	5,00	2,14	2,34	5,00	2,65	1,89	4,68	2,71	1,73
2	—	—	—	5,00	1,40	3,57	5,00	1,79	2,79	5,00	2,18	2,29	4,80	2,40	2,00
7	—	—	—	5,00	0,98	5,10	5,00	1,31	3,82	5,00	1,65	3,03	4,58	1,90	2,41

WH-UDZ07KE5

Tamb	HC	IP	COP	HC	IP	COP	HC	IP	COP	HC	IP	COP	HC	IP	COP
LWC	25	25	25	35	35	35	45	45	45	55	55	55	60	60	60
-20	—	—	—	4,45	2,12	2,10	4,23	2,48	1,71	3,90	2,85	1,37	—	—	—
-15	—	—	—	5,60	2,38	2,35	5,30	2,78	1,91	5,00	3,20	1,56	—	—	—
-7	—	—	—	5,75	1,95	2,95	5,65	2,30	2,46	5,35	2,70	1,98	4,98	2,90	1,72
2	—	—	—	6,85	2,00	3,43	6,75	2,40	2,81	6,25	2,80	2,23	6,18	2,91	2,12
7	—	—	—	7,00	1,44	4,86	7,00	1,92	3,65	7,00	2,40	2,92	6,86	2,73	2,51

WH-UDZ09KE5

Tamb	HC	IP	COP	HC	IP	COP	HC	IP	COP	HC	IP	COP	HC	IP	COP
LWC	25	25	25	35	35	35	45	45	45	55	55	55	60	60	60
-20	—	—	—	4,95	2,43	2,04	4,58	2,70	1,70	4,04	3,00	1,35	—	—	—
-15	—	—	—	7,40	3,20	2,31	6,45	3,28	1,97	5,40	3,42	1,58	—	—	—
-7	—	—	—	6,25	2,20	2,84	6,10	2,68	2,28	5,90	3,06	1,93	5,65	3,24	1,74
2	—	—	—	7,00	2,06	3,40	6,85	2,50	2,74	6,30	2,89	2,18	7,26	3,31	2,19
7	—	—	—	9,00	1,98	4,55	9,00	2,58	3,49	8,90	3,04	2,93	8,60	3,42	2,51

Aquarea High Performance Bi-bloc K Series Single phase. Heating and Cooling · R32

Outdoor		WH-UDZ03KE5									WH-UDZ05KE5								
Tamb	CC	IP	EER	CC	IP	EER	CC	IP	EER	CC	IP	EER	CC	IP	EER	CC	IP	EER	
LWC	7	7	7	14	14	14	18	18	18	7	7	7	14	14	14	18	18	18	
16	3,56	0,57	6,25	4,32	0,55	7,85	3,47	0,41	8,46	—	—	—	—	—	—	—	—	—	
25	3,29	0,73	4,51	4,06	0,72	5,64	3,27	0,52	6,29	5,47	1,37	3,99	6,62	1,39	4,76	5,54	0,80	6,93	
35	3,20	0,91	3,52	3,56	0,93	3,83	3,20	0,68	4,71	5,00	1,64	3,05	6,69	1,76	3,80	5,00	1,02	4,90	
43	2,68	1,06	2,53	3,34	1,09	3,06	2,79	0,82	3,40	4,18	1,83	2,28	5,54	1,84	3,01	4,45	1,27	3,50	
Outdoor		WH-UDZ07KE5									WH-UDZ09KE5								
Tamb	CC	IP	EER	CC	IP	EER	CC	IP	EER	CC	IP	EER	CC	IP	EER	CC	IP	EER	
LWC	7	7	7	14	14	14	18	18	18	7	7	7	14	14	14	18	18	18	
25	6,32	1,72	3,67	8,16	1,93	4,23	6,63	1,12	5,92	8,31	2,50	3,32	10,43	2,67	3,91	8,85	1,72	5,15	
35	6,70	2,21	3,03	8,19	2,42	3,38	6,70	1,42	4,72	8,20	3,02	2,72	10,28	3,25	3,16	9,00	2,15	4,19	
43	5,72	2,62	2,18	7,47	2,80	2,67	6,15	1,78	3,46	5,00	2,15	2,33	6,38	2,15	2,97	7,02	2,14	3,28	

Tamb: Ambient Temperature (°C). LWC: Leaving Water Condenser Temperature (°C). HC: Heating Capacity (kW). CC: Cooling Capacity (kW). IP: Input Power (kW). This data is measured by Panasonic in accordance with EN14511-2 standard. This data is for reference purpose only, and does not guarantee the performance.

Aquarea High Performance Bi-bloc H Series Single phase / Three phase. Heating and Cooling - R410A

WH-UD12HE5																		
Tamb	HC	IP	COP	HC	IP	COP	HC	IP	COP	HC	IP	COP	HC	IP	COP	HC	IP	COP
LWC	30	30	30	35	35	35	40	40	40	45	45	45	50	50	50	55	55	55
-15	9,30	3,46	2,69	8,90	3,62	2,46	8,50	3,79	2,24	8,10	3,95	2,05	7,50	4,05	1,85	7,00	4,16	1,68
-7	10,40	3,37	3,09	10,00	3,66	2,73	9,60	3,95	2,43	9,20	4,24	2,17	8,70	4,26	2,04	8,20	4,27	1,92
2	11,80	3,10	3,81	11,40	3,31	3,44	11,00	3,53	3,12	10,60	3,74	2,83	9,80	3,94	2,49	9,10	4,14	2,20
7	12,00	2,10	5,71	12,00	2,53	4,74	12,00	2,96	4,05	12,00	3,39	3,54	12,00	3,78	3,17	12,00	4,16	2,88
25	12,00	1,38	8,70	12,00	1,66	7,23	11,80	1,94	6,08	11,70	2,23	5,25	11,50	2,49	4,62	11,40	2,74	4,16
WH-UD16HE5																		
Tamb	HC	IP	COP	HC	IP	COP	HC	IP	COP	HC	IP	COP	HC	IP	COP	HC	IP	COP
LWC	30	30	30	35	35	35	40	40	40	45	45	45	50	50	50	55	55	55
-15	10,60	4,09	2,59	10,30	4,38	2,35	10,00	4,67	2,14	9,70	4,96	1,96	8,80	4,94	1,78	7,90	4,91	1,61
-7	11,90	4,03	2,95	11,40	4,43	2,57	10,80	4,83	2,24	10,30	5,22	1,97	9,60	5,09	1,89	9,00	4,95	1,82
2	13,50	3,74	3,61	13,00	3,96	3,28	12,40	4,18	2,97	11,90	4,40	2,70	10,80	4,46	2,42	9,80	4,51	2,17
7	16,00	3,21	4,98	16,00	3,74	4,28	16,00	4,27	3,75	16,00	4,80	3,33	15,20	5,11	2,97	14,50	5,41	2,68
25	16,00	2,31	6,93	16,00	2,69	5,95	16,00	3,07	5,21	16,00	3,45	4,64	16,00	3,67	4,36	15,90	3,89	4,09
WH-UD09HE8																		
Tamb	HC	IP	COP	HC	IP	COP	HC	IP	COP	HC	IP	COP	HC	IP	COP	HC	IP	COP
LWC	30	30	30	35	35	35	40	40	40	45	45	45	50	50	50	55	55	55
-15	8,65	3,06	2,83	8,30	3,21	2,59	7,95	3,41	2,33	7,60	3,61	2,11	7,15	3,71	1,93	6,70	3,81	1,76
-7	9,35	2,91	3,21	9,00	3,16	2,85	8,85	3,54	2,50	8,70	3,92	2,22	8,30	3,89	2,13	7,90	3,86	2,05
2	9,31	2,35	3,96	9,00	2,51	3,59	9,00	2,78	3,24	9,00	3,05	2,95	8,90	3,49	2,55	8,80	3,94	2,23
7	9,00	1,54	5,84	9,00	1,86	4,84	9,00	2,16	4,17	9,00	2,46	3,66	9,00	2,76	3,26	9,00	3,06	2,94
25	9,00	1,05	8,57	9,00	1,24	7,26	8,73	1,44	6,06	8,46	1,64	5,16	8,28	1,82	4,55	8,10	2,00	4,05
WH-UD12HE8																		
Tamb	HC	IP	COP	HC	IP	COP	HC	IP	COP	HC	IP	COP	HC	IP	COP	HC	IP	COP
LWC	30	30	30	35	35	35	40	40	40	45	45	45	50	50	50	55	55	55
-15	9,30	3,46	2,69	8,90	3,62	2,46	8,50	3,79	2,24	8,10	3,95	2,05	7,50	4,05	1,85	7,00	4,16	1,68
-7	10,40	3,37	3,09	10,00	3,66	2,73	9,60	3,95	2,43	9,20	4,24	2,17	8,70	4,26	2,04	8,20	4,27	1,92
2	11,80	3,10	3,81	11,40	3,31	3,44	11,00	3,53	3,12	10,60	3,74	2,83	9,80	3,94	2,49	9,10	4,14	2,20
7	12,00	2,10	5,71	12,00	2,53	4,74	12,00	2,96	4,05	12,00	3,39	3,54	12,00	3,78	3,17	12,00	4,16	2,88
25	12,00	1,38	8,70	12,00	1,66	7,23	11,80	1,94	6,08	11,70	2,23	5,25	11,50	2,49	4,62	11,40	2,74	4,16
WH-UD16HE8																		
Tamb	HC	IP	COP	HC	IP	COP	HC	IP	COP	HC	IP	COP	HC	IP	COP	HC	IP	COP
LWC	30	30	30	35	35	35	40	40	40	45	45	45	50	50	50	55	55	55
-15	10,60	4,09	2,59	10,30	4,38	2,35	10,00	4,67	2,14	9,70	4,96	1,96	8,80	4,94	1,78	7,90	4,91	1,61
-7	11,90	4,03	2,95	11,40	4,43	2,57	10,80	4,83	2,24	10,30	5,22	1,97	9,60	5,09	1,89	9,00	4,95	1,82
2	13,50	3,74	3,61	13,00	3,96	3,28	12,40	4,18	2,97	11,90	4,40	2,70	10,80	4,46	2,42	9,80	4,51	2,17
7	16,00	3,21	4,98	16,00	3,74	4,28	16,00	4,27	3,75	16,00	4,80	3,33	15,20	5,11	2,97	14,50	5,41	2,68
25	16,00	2,31	6,93	16,00	2,69	5,95	16,00	3,07	5,21	16,00	3,45	4,64	16,00	3,67	4,36	15,90	3,89	4,09

Aquarea High Performance Bi-bloc H Series Single phase / Three phase. Heating and Cooling - R410A

Outdoor	WH-UD12HE5									WH-UD16HE5																	
Tamb	CC	IP	EER	CC	IP	EER	CC	IP	EER	CC	IP	EER	CC	IP	EER	CC	IP	EER									
LWC	7	7	7	14	14	14	18	18	18	7	7	7	14	14	14	18	18	18									
16	7,86	1,18	6,66	13,15	1,40	9,39	10,00	1,73	5,78	9,20	1,62	5,68	16,40	2,58	6,36	12,20	2,45	4,98									
25	12,08	2,90	4,17	15,70	2,05	7,66	10,00	1,97	5,08	14,40	3,92	3,67	19,20	3,83	5,01	12,20	2,79	4,37									
35	10,00	3,56	2,81	12,00	2,67	4,49	10,00	2,40	4,17	12,20	4,76	2,56	15,00	4,98	3,01	12,20	2,96	4,12									
43	7,80	3,80	2,05	11,10	3,19	3,48	8,00	2,85	2,81	7,75	3,40	2,28	13,80	5,95	2,32	9,70	4,00	2,43									
Outdoor	WH-UD09HE8									WH-UD12HE8									WH-UD16HE8								
Tamb	CC	IP	EER	CC	IP	EER	CC	IP	EER	CC	IP	EER	CC	IP	EER	CC	IP	EER									
LWC	7	7	7	14	14	14	18	18	18	7	7	7	14	14	14	18	18	18									
16	7,50	1,15	6,52	9,10	1,20	7,58	7,00	1,13	6,19	7,86	1,18	6,66	13,15	1,40	9,39	10,00	1,73	5,78									
25	8,35	1,77	4,72	10,90	1,78	6,12	7,00	1,24	5,65	12,08	2,90	4,17	15,70	2,05	7,66	10,00	1,97	5,08									
35	7,00	2,23	3,14	8,30	2,32	3,58	7,00	1,52	4,61	10,00	2,56	3,91	12,00	2,67	4,49	10,00	2,40	4,17									
43	5,52	2,54	2,17	7,69	2,77	2,78	5,60	1,80	3,11	7,80	3,80	2,05	11,10	3,19	3,48	8,00	2,85	2,81									

Tamb: Ambient Temperature (°C). LWC: Leaving Water Condenser Temperature (°C). HC: Heating Capacity (kW). CC: Cooling Capacity (kW). IP: Input Power (kW). This data is measured by Panasonic in accordance with EN14511-2 standard. This data is for reference purpose only, and does not guarantee the performance.

Heating and cooling capacity tables

Based on outlet temperature and outside temperature.

Aquarea T-CAP Bi-bloc K Series Single phase / Three phase. Heating and Cooling - R32

WH-UXZ09KE5

Tamb	HC	IP	COP	HC	IP	COP	HC	IP	COP	HC	IP	COP
LWC	35	35	35	45	45	45	55	55	55	60	60	60
-20	8,80	4,79	1,84	8,80	5,30	1,66	8,55	5,90	1,45	—	—	—
-15	9,00	3,45	2,61	9,00	4,30	2,09	9,00	4,95	1,82	—	—	—
-7	9,00	3,00	3,00	9,00	3,82	2,36	9,00	4,28	2,10	—	—	—
2	9,00	2,44	3,69	9,00	3,05	2,95	9,00	3,90	2,31	—	—	—
7	9,00	1,79	5,03	9,00	2,42	3,72	9,00	2,93	3,07	—	—	—
25	7,95	1,20	6,63	9,00	1,56	5,77	11,30	3,13	3,61	11,00	2,86	3,85

WH-UXZ12KE5

Tamb	HC	IP	COP	HC	IP	COP	HC	IP	COP	HC	IP	COP
LWC	35	35	35	45	45	45	55	55	55	60	60	60
-20	11,50	6,05	1,90	10,20	6,02	1,69	8,70	6,00	1,45	—	—	—
-15	12,00	4,90	2,45	11,00	5,38	2,04	10,50	6,20	1,69	—	—	—
-7	12,00	4,41	2,72	12,00	5,54	2,17	12,00	6,00	2,00	—	—	—
2	12,00	3,49	3,44	12,00	4,25	2,82	12,00	5,24	2,29	—	—	—
7	12,10	2,50	4,84	12,10	3,38	3,58	12,10	3,98	3,04	—	—	—
25	10,90	1,61	6,77	10,87	2,44	4,45	11,30	3,13	3,61	12,00	3,11	3,86

WH-UXZ09KE8

Tamb	HC	IP	COP	HC	IP	COP	HC	IP	COP	HC	IP	COP
LWC	35	35	35	45	45	45	55	55	55	60	60	60
-20	8,80	4,79	1,84	8,80	5,30	1,66	8,55	5,90	1,45	—	—	—
-15	9,00	3,45	2,61	9,00	4,30	2,09	9,00	4,95	1,82	8,80	6,37	1,38
-7	9,00	3,00	3,00	9,00	3,82	2,36	9,00	4,28	2,10	9,00	4,72	1,91
2	9,00	2,44	3,69	9,00	3,05	2,95	9,00	3,90	2,31	9,00	4,05	2,22
7	9,00	1,79	5,03	9,00	2,42	3,72	9,00	2,93	3,07	9,00	3,43	2,62
25	7,95	1,20	6,63	9,00	1,56	5,77	11,30	3,13	3,61	11,00	2,86	3,85

WH-UXZ12KE8

Tamb	HC	IP	COP	HC	IP	COP	HC	IP	COP	HC	IP	COP
LWC	35	35	35	45	45	45	55	55	55	60	60	60
-20	11,50	6,05	1,90	10,20	6,02	1,69	8,70	6,00	1,45	—	—	—
-15	12,00	4,90	2,45	11,00	5,38	2,04	10,50	6,20	1,69	—	—	—
-7	12,00	4,41	2,72	12,00	5,54	2,17	12,00	5,24	2,29	11,80	6,59	1,79
2	12,00	3,49	3,44	12,00	4,25	2,82	12,00	5,24	2,29	12,00	5,77	2,08
7	12,10	2,50	4,84	12,10	3,38	3,58	12,10	3,98	3,04	12,00	4,52	2,65
25	10,90	1,61	6,77	10,87	2,44	4,45	11,30	3,13	3,61	12,00	3,11	3,86

WH-UXZ16KE8

Tamb	HC	IP	COP	HC	IP	COP	HC	IP	COP	HC	IP	COP
LWC	35	35	35	45	45	45	55	55	55	60	60	60
-20	16,00	8,20	1,95	15,00	9,00	1,67	12,00	9,30	1,29	—	—	—
-15	16,00	6,91	2,32	16,00	8,44	1,90	16,00	9,97	1,60	—	—	—
-7	16,00	6,70	2,39	16,00	7,85	2,04	16,00	9,33	1,71	15,00	9,70	1,55
2	16,00	5,16	3,10	16,00	6,40	2,50	16,00	7,72	2,07	16,00	9,20	1,74
7	16,00	3,65	4,38	16,00	4,72	3,39	16,00	5,88	2,72	15,20	5,90	2,58
25	16,00	2,30	6,96	16,00	3,20	5,00	16,00	4,00	4,00	14,50	4,30	3,37

Aquarea T-CAP Bi-bloc K Series Single phase / Three phase. Heating and Cooling - R32

Outdoor		WH-UXZ09KE5									WH-UXZ12KE5																	
Tamb	CC	IP	EER	CC	IP	EER	CC	IP	EER	CC	IP	EER	CC	IP	EER	CC	IP	EER										
LWC	7	7	7	14	14	14	18	18	18	7	7	7	14	14	14	18	18	18										
25	8,98	2,37	3,79	10,60	2,41	4,40	9,00	1,57	5,73	11,10	3,35	3,31	13,03	3,43	3,80	11,63	2,34	4,97										
35	8,80	2,83	3,11	9,07	3,01	3,01	8,80	1,90	4,63	10,70	4,00	2,68	11,42	4,20	2,72	10,70	2,73	3,92										
43	6,48	3,27	1,98	7,65	3,27	2,34	6,68	2,46	2,72	6,62	3,29	2,01	7,89	3,30	2,39	8,68	3,28	2,65										
Outdoor		WH-UXZ09KE8									WH-UXZ12KE8									WH-UXZ16KE8								
Tamb	CC	IP	EER	CC	IP	EER	CC	IP	EER	CC	IP	EER	CC	IP	EER	CC	IP	EER	CC	IP	EER	CC	IP	EER				
LWC	7	7	7	14	14	14	18	18	18	7	7	7	14	14	14	18	18	18	7	7	7	14	14	14	18	18	18	
25	8,98	2,37	3,79	10,60	2,41	4,40	9,00	1,57	5,73	11,10	3,35	3,31	13,03	3,43	3,80	11,63	2,34	4,97	15,00	4,00	3,75	17,00	4,20	4,05	17,00	3,40	5,00	
35	8,80	2,83	3,11	9,07	3,01	3,01	8,80	1,90	4,63	10,70	4,00	2,68	11,42	4,20	2,72	10,70	2,73	3,92	13,40	5,08	2,64	15,50	5,30	2,92	13,40	5,08	2,64	
43	6,48	3,27	1,98	7,65	3,27	2,34	6,68	2,46	2,72	6,62	3,29	2,01	7,89	3,30	2,39	8,68	3,28	2,65	8,80	4,20	2,10	10,50	4,30	2,44	11,50	4,20	2,74	

Tamb: Ambient Temperature (°C). LWC: Leaving Water Condenser Temperature (°C). HC: Heating Capacity (kW). CC: Cooling Capacity (kW). IP: Input Power (kW). This data is measured by Panasonic in accordance with EN14511-2 standard. This data is for reference purpose only, and does not guarantee the performance.

Aquarea T-CAP Bi-bloc H Series Single phase / Three phase. Heating and Cooling · R410A

WH-UX09HE5																		
Tamb	HC	IP	COP	HC	IP	COP	HC	IP	COP	HC	IP	COP	HC	IP	COP	HC	IP	COP
LWC	30	30	30	35	35	35	40	40	40	45	45	45	50	50	50	55	55	55
-15	9,00	3,24	2,78	9,00	3,51	2,56	9,00	3,91	2,30	9,00	4,30	2,09	9,00	4,73	1,90	9,00	5,16	1,74
-7	9,00	2,71	3,32	9,00	3,16	2,85	9,00	3,62	2,49	9,00	4,07	2,21	9,00	4,27	2,11	9,00	4,46	2,02
2	9,00	2,36	3,81	9,00	2,51	3,59	9,00	2,78	3,24	9,00	3,05	2,95	9,00	3,56	2,53	9,00	4,07	2,21
7	9,00	1,64	5,49	9,00	1,86	4,84	9,00	2,16	4,17	9,00	2,46	3,66	9,00	2,76	3,26	9,00	3,06	2,94
25	13,60	1,50	9,07	13,60	1,71	7,95	13,20	1,93	6,84	12,80	2,14	5,98	12,00	2,41	4,98	11,20	2,67	4,19
WH-UX12HE5																		
Tamb	HC	IP	COP	HC	IP	COP	HC	IP	COP	HC	IP	COP	HC	IP	COP	HC	IP	COP
LWC	30	30	30	35	35	35	40	40	40	45	45	45	50	50	50	55	55	55
-15	12,00	4,75	2,53	12,00	4,96	2,42	12,00	5,41	2,22	11,00	5,38	2,04	10,80	5,82	1,86	10,50	6,26	1,68
-7	12,00	3,85	3,12	12,00	4,41	2,72	12,00	4,98	2,41	12,00	5,54	2,17	12,00	5,90	2,03	12,00	6,26	1,92
2	12,00	3,19	3,76	12,00	3,49	3,44	12,00	3,87	3,10	12,00	4,25	2,82	12,00	4,86	2,47	12,00	5,47	2,19
7	12,00	2,18	5,50	12,00	2,53	4,74	12,00	2,96	4,05	12,00	3,39	3,54	12,00	3,78	3,17	12,00	4,16	2,88
25	13,60	1,55	8,77	13,60	1,76	7,73	13,40	2,10	6,38	13,20	2,43	5,43	12,60	2,66	4,74	12,00	2,89	4,15
WH-UX09HE8																		
Tamb	HC	IP	COP	HC	IP	COP	HC	IP	COP	HC	IP	COP	HC	IP	COP	HC	IP	COP
LWC	30	30	30	35	35	35	40	40	40	45	45	45	50	50	50	55	55	55
-15	9,00	3,24	2,78	9,00	3,51	2,56	9,00	3,91	2,30	9,00	4,30	2,09	9,00	4,73	1,90	9,00	5,16	1,74
-7	9,00	2,71	3,32	9,00	3,16	2,85	9,00	3,62	2,49	9,00	4,07	2,21	9,00	4,27	2,11	9,00	4,46	2,02
2	9,00	2,36	3,81	9,00	2,51	3,59	9,00	2,78	3,24	9,00	3,05	2,95	9,00	3,56	2,53	9,00	4,07	2,21
7	9,00	1,64	5,49	9,00	1,86	4,84	9,00	2,16	4,17	9,00	2,46	3,66	9,00	2,76	3,26	9,00	3,06	2,94
25	13,60	1,50	9,07	13,60	1,71	7,95	13,20	1,93	6,84	12,80	2,14	5,98	12,00	2,41	4,98	11,20	2,67	4,19
WH-UX12HE8																		
Tamb	HC	IP	COP	HC	IP	COP	HC	IP	COP	HC	IP	COP	HC	IP	COP	HC	IP	COP
LWC	30	30	30	35	35	35	40	40	40	45	45	45	50	50	50	55	55	55
-15	12,00	4,75	2,53	12,00	4,96	2,42	12,00	5,41	2,22	12,00	5,86	2,05	11,80	6,24	1,89	11,60	6,62	1,75
-7	12,00	3,85	3,12	12,00	4,41	2,72	12,00	4,98	2,41	12,00	5,54	2,17	12,00	5,90	2,03	12,00	6,26	1,92
2	12,00	3,19	3,76	12,00	3,49	3,44	12,00	3,87	3,10	12,00	4,25	2,82	12,00	4,86	2,47	12,00	5,47	2,19
7	12,00	2,18	5,50	12,00	2,53	4,74	12,00	2,96	4,05	12,00	3,39	3,54	12,00	3,78	3,17	12,00	4,16	2,88
25	13,60	1,55	8,77	13,60	1,76	7,73	13,40	2,10	6,38	13,20	2,43	5,43	12,60	2,66	4,74	12,00	2,89	4,15
WH-UX16HE8																		
Tamb	HC	IP	COP	HC	IP	COP	HC	IP	COP	HC	IP	COP	HC	IP	COP	HC	IP	COP
LWC	30	30	30	35	35	35	40	40	40	45	45	45	50	50	50	55	55	55
-15	16,00	6,30	2,54	16,00	6,89	2,32	16,00	7,45	2,15	16,00	8,10	1,98	16,00	8,48	1,89	15,20	8,96	1,70
-7	16,00	5,85	2,74	16,00	6,42	2,49	16,00	7,00	2,29	16,00	7,57	2,11	16,00	8,10	1,98	16,00	8,62	1,86
2	16,00	4,67	3,43	16,00	5,21	3,07	16,00	5,74	2,79	16,00	6,31	2,54	16,00	6,90	2,32	16,00	7,50	2,13
7	16,00	3,35	4,78	16,00	3,74	4,28	16,00	4,30	3,72	16,00	4,80	3,33	16,00	5,43	2,95	16,00	5,91	2,71
16	16,00	2,59	6,18	16,00	3,18	5,03	16,00	3,71	4,31	16,00	4,27	3,75	16,00	4,86	3,29	16,00	5,22	3,07
25	16,00	2,02	7,92	16,00	2,58	6,20	16,00	2,91	5,50	16,00	3,36	4,76	16,00	3,74	4,28	16,00	4,00	4,00

Aquarea T-CAP Bi-bloc H Series Single phase / Three phase. Heating and Cooling · R410A

Outdoor		WH-UX09HE5									WH-UX12HE5								
Tamb	CC	IP	EER	CC	IP	EER	CC	IP	EER	CC	IP	EER	CC	IP	EER	CC	IP	EER	
LWC	7	7	7	14	14	14	18	18	18	7	7	7	14	14	14	18	18	18	
18	7,00	1,36	5,15	8,55	1,41	6,06	7,00	1,00	7,00	10,00	1,75	5,71	13,20	1,96	6,73	10,00	1,40	7,14	
25	7,65	1,91	4,01	11,10	1,98	5,61	7,00	1,10	6,36	11,20	2,67	4,19	16,50	3,01	5,48	10,00	1,60	6,25	
35	7,00	2,21	3,17	9,23	2,37	3,89	7,00	1,35	5,19	10,00	3,56	2,81	12,55	3,63	3,46	10,00	1,95	5,13	
43	6,25	2,66	2,35	8,55	2,71	3,15	5,60	1,60	3,50	8,00	3,35	2,39	10,00	3,46	2,89	8,00	2,30	3,48	
Outdoor		WH-UX09HE8						WH-UX12HE8						WH-UX16HE8					
Tamb	CC	IP	EER	CC	IP	EER	CC	IP	EER	CC	IP	EER	CC	IP	EER	CC	IP	EER	
LWC	7	7	7	18	18	18	7	7	7	18	18	18	7	7	7	18	18	18	
18	7,00	1,36	5,15	—	—	—	7,50	1,41	5,32	—	—	—	8,50	1,70	5,00	10,00	1,70	5,88	
25	7,65	1,91	4,01	—	—	—	8,90	2,16	4,12	—	—	—	14,00	4,00	3,50	14,00	2,94	4,76	
35	7,00	2,21	3,17	—	—	—	10,00	3,56	2,81	—	—	—	12,20	4,76	2,56	12,20	3,50	3,49	
43	6,25	2,66	2,35	—	—	—	8,00	3,01	2,66	—	—	—	7,10	3,31	2,15	9,80	3,31	2,96	

Tamb: Ambient Temperature [°C]. LWC: Leaving Water Condenser Temperature [°C]. HC: Heating Capacity (kW). CC: Cooling Capacity (kW). IP: Input Power (kW). This data is measured by Panasonic in accordance with EN14511-2 standard. This data is for reference purpose only, and does not guarantee the performance.

Heating and cooling capacity tables

Based on outlet temperature and outside temperature.

Aquarea T-CAP Bi-bloc H Series Three phase. Super Quiet outdoor unit. Heating and Cooling - SQC · R410A

WH-UQ09HE8

Tamb	HC	IP	COP	HC	IP	COP	HC	IP	COP	HC	IP	COP	HC	IP	COP	HC	IP	COP
LWC	30	30	30	35	35	35	40	40	40	45	45	45	50	50	50	55	55	55
-15	9,00	3,24	2,78	9,00	3,51	2,56	9,00	3,91	2,30	9,00	4,30	2,09	9,00	4,73	1,90	9,00	5,16	1,74
-7	9,00	2,71	3,32	9,00	3,16	2,85	9,00	3,62	2,49	9,00	4,07	2,21	9,00	4,27	2,11	9,00	4,46	2,02
2	9,00	2,36	3,81	9,00	2,51	3,59	9,00	2,78	3,24	9,00	3,05	2,95	9,00	3,56	2,53	9,00	4,07	2,21
7	9,00	1,64	5,49	9,00	1,86	4,84	9,00	2,16	4,17	9,00	2,46	3,66	9,00	2,76	3,26	9,00	3,06	2,94
25	13,60	1,50	9,07	13,60	1,71	7,95	13,20	1,93	6,84	12,80	2,14	5,98	12,00	2,41	4,98	11,20	2,67	4,19

WH-UQ12HE8

Tamb	HC	IP	COP	HC	IP	COP	HC	IP	COP	HC	IP	COP	HC	IP	COP	HC	IP	COP
LWC	30	30	30	35	35	35	40	40	40	45	45	45	50	50	50	55	55	55
-15	12,00	4,75	2,53	12,00	4,96	2,42	12,00	5,41	2,22	12,00	5,86	2,05	11,80	6,24	1,89	11,60	6,62	1,75
-7	12,00	3,85	3,12	12,00	4,41	2,72	12,00	4,98	2,41	12,00	5,54	2,17	12,00	5,90	2,03	12,00	6,26	1,92
2	12,00	3,19	3,76	12,00	3,49	3,44	12,00	3,87	3,10	12,00	4,25	2,82	12,00	4,86	2,47	12,00	5,47	2,19
7	12,00	2,18	5,50	12,00	2,53	4,74	12,00	2,96	4,05	12,00	3,39	3,54	12,00	3,78	3,17	12,00	4,16	2,88
25	13,60	1,55	8,77	13,60	1,76	7,73	13,40	2,10	6,38	13,20	2,43	5,43	12,60	2,66	4,74	12,00	2,89	4,15

WH-UQ16HE8

Tamb	HC	IP	COP	HC	IP	COP	HC	IP	COP	HC	IP	COP	HC	IP	COP	HC	IP	COP
LWC	30	30	30	35	35	35	40	40	40	45	45	45	50	50	50	55	55	55
-15	16,00	6,30	2,54	16,00	6,89	2,32	16,00	7,45	2,15	16,00	8,10	1,98	16,00	8,48	1,89	15,20	8,96	1,70
-7	16,00	5,85	2,74	16,00	6,42	2,49	16,00	7,00	2,29	16,00	7,57	2,11	16,00	8,10	1,98	16,00	8,62	1,86
2	16,00	4,67	3,43	16,00	5,21	3,07	16,00	5,74	2,79	16,00	6,31	2,54	16,00	6,90	2,32	16,00	7,50	2,13
7	16,00	3,35	4,78	16,00	3,74	4,28	16,00	4,30	3,72	16,00	4,80	3,33	16,00	5,43	2,95	16,00	5,91	2,71
16	16,00	2,59	6,18	16,00	3,18	5,03	16,00	3,71	4,31	16,00	4,27	3,75	16,00	4,86	3,29	16,00	5,22	3,07
25	16,00	2,02	7,92	16,00	2,58	6,20	16,00	2,91	5,50	16,00	3,36	4,76	16,00	3,74	4,28	16,00	4,00	4,00

Aquarea T-CAP Bi-bloc H Series Three phase. Super Quiet outdoor unit. Heating and Cooling - SQC · R410A

WH-UQ09HE8

Tamb	CC	IP	EER	CC	IP	EER
LWC	7	7	7	18	18	18
18	7,00	1,36	5,15	—	—	—
25	7,65	1,91	4,01	—	—	—
35	7,00	2,21	3,17	—	—	—
43	6,25	2,66	2,35	—	—	—

WH-UQ12HE8

Tamb	CC	IP	EER	CC	IP	EER
LWC	7	7	7	18	18	18
18	7,50	1,41	5,32	—	—	—
25	8,90	2,16	4,12	—	—	—
35	10,00	3,56	2,81	—	—	—
43	8,00	3,01	2,66	—	—	—

WH-UQ16HE8

Tamb	CC	IP	EER	CC	IP	EER
LWC	7	7	7	18	18	18
18	8,50	1,70	5,00	10,00	1,70	5,88
25	14,00	4,00	3,50	14,00	2,94	4,76
35	12,20	4,76	2,56	12,20	3,50	3,49
43	7,10	3,31	2,15	9,80	3,31	2,96

Tamb: Ambient Temperature [°C]. LWC: Leaving Water Condenser Temperature [°C]. HC: Heating Capacity [kW]. CC: Cooling Capacity [kW]. IP: Input Power [kW]. This data is measured by Panasonic in accordance with EN14511-2 standard. This data is for reference purpose only, and does not guarantee the performance.

Examples of installations

**Aquarea H and J Series:
Bivalent with buffer tank and mixing valve**

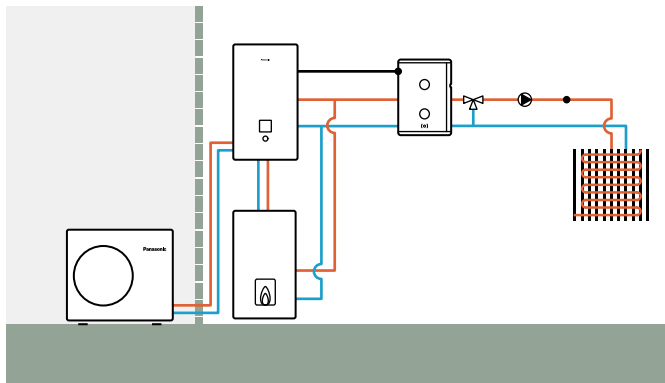

**Aquarea H and J Series:
Buffer tank with solar and mixing valve**

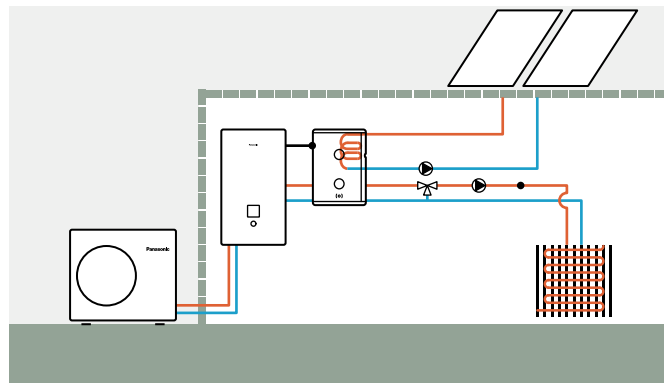

**Aquarea H and J Series:
2 zones with external kit without buffer tank**

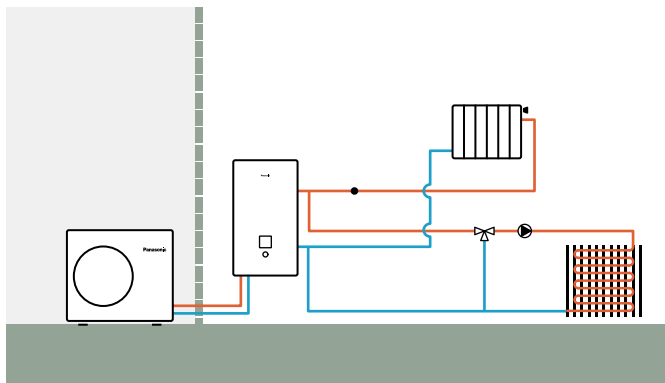

**Aquarea H and J Series:
2 zones with external kit, buffer tank and swimming pool**

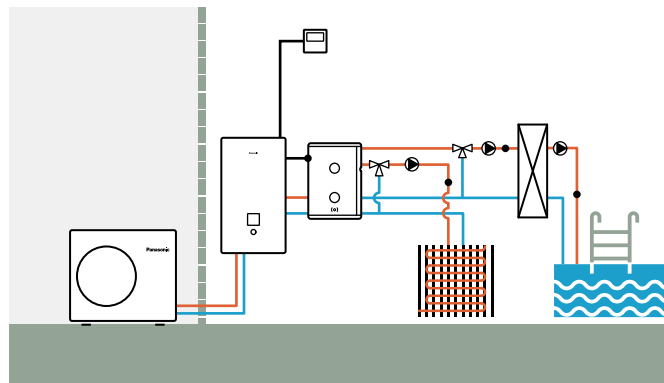

**Aquarea All in One H and J Series:
2 zones with external kit, without buffer tank**

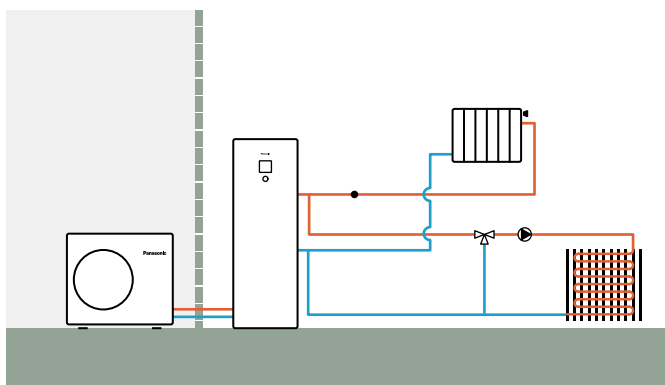

**Aquarea All in One 2 zones H and J Series:
2 zones built-in, without buffer tank**

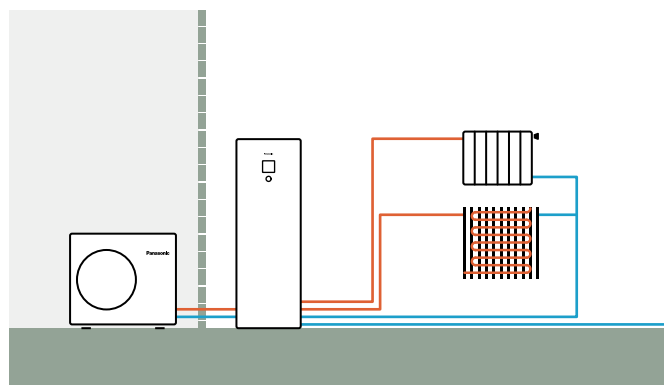

Panasonic Marketing Europe GmbH
Panasonic Heating & Ventilation Air-Conditioning Europe

Hagenauer Strasse 43, 65203 Wiesbaden, Germany
www.aircon.panasonic.eu

Ireland

Panasonic Heating & Cooling Solutions

1 The Courtyard, Kiltarbery Business Park, Nangor
 Road, Dublin D22 R791, Ireland
 ☎ 1800 939 977
 www.aircon.panasonic.ie

France / Belgium / Luxemburg

Panasonic Solutions Chauffage & Refroidissement

1 à 7 Rue du 19 Mars 1962, 92238, Gennevilliers
 Cedex, France
 ☎ 0800 805 215 (France)
 +32 2 320 55 38 (Belgium & Luxemburg)
 www.aircon.panasonic.eu

Germany / Austria / Switzerland

Panasonic Heiz- & Kühlsysteme

Hagenauer Str. 43, 65203 Wiesbaden, Germany
 +49 611 711 87 211 (Germany)
 ☎ +43 1 253 22 120 (Austria)
 +41 41 561 53 66 (Switzerland)
 HLK-Support-DE@eu.panasonic.com (Germany)
 ☎ HLK-Support-AT@eu.panasonic.com (Austria)
 HLK-Support-CH@eu.panasonic.com (Switzerland)
 www.aircon.panasonic.eu

Poland

Panasonic Heating & Cooling Solutions

Wotoska 9, 02-583, Warszawa, Polska
 ☎ 800 080 911
 ☎ info.pl@panasonicproclub.com
 www.aircon.panasonic.pl

The Netherlands

Panasonic Heating & Cooling Solutions

Europalaan 28E, 5332 BC, 's-Hertogenbosch,
 The Netherlands
 ☎ +31 736 402 538
 www.aircon.panasonic.nl

Spain / Portugal

Panasonic Heating & Cooling Solutions

WTC Almeda Park, plaza de la Pau s/n, Edificio 6,
 planta 4ª, Local D - 08940 Cornellà de Llobregat,
 Spain
 ☎ 900 82 87 87 (Spain)
 800 78 22 20 (Portugal)
 www.aircon.panasonic.eu

Italy / Malta / Cyprus / Greece

Panasonic Heating & Cooling Solutions

Viale dell'Innovazione, 3, 20126, Milano, Italy
 ☎ +39 02 6433235 (Customer Service)
 www.aircon.panasonic.eu

Sweden / Denmark / Norway / Finland

Panasonic Heating & Cooling Solutions

Sundbybergsvägen 1, 171 73 Solna, Sweden
 +46 85 221 81 00 (Sweden)
 ☎ +45 89 87 45 00 (Denmark)
 +47 69 67 61 00 (Norway)
 +35 86 46 04 15 90 (Finland)
 www.aircon.panasonic.eu

Czech Republic / Slovakia

Panasonic Heating & Cooling Solutions

Křižíkova 148/34, 186 00 Praha 8, Czech Republic
 ☎ +420 236 032 911
 ☎ panasonic.praha@eu.panasonic.com
 www.aircon.panasonic.cz

Hungary / Albania / Bosnia / Bulgaria / Croatia / Kosovo / Montenegro / Romania / Serbia / Slovenia

Panasonic Heating & Cooling Solutions

Alíz utca 3. - Office Garden III, 1117 Budapest,
 Hungary
 ☎ +36 1 700 89 65
 ☎ panasonicaquarea@eu.panasonic.com
 www.aircon.panasonic.eu

United Kingdom

Panasonic Heating & Ventilation Air-Conditioning UK Ltd.

Building 3, Albany Place, Hydeway, Welwyn Garden City, AL7 3BT, United Kingdom
 ☎ +44 1707 378 670
 ☎ sales.PHVACUK@eu.panasonic.com
www.aircon.panasonic.co.uk



Do not add or replace refrigerant other than the specified type. Manufacturer is not responsible for the damage and deterioration in safety due to usage of the other refrigerant.
 The outdoor units in this catalogue contains fluorinated greenhouse gases with a GWP higher than 150.

Panasonic®

To find out how Panasonic cares for you,
 log on to: **www.aircon.panasonic.eu**

Panasonic Marketing Europe GmbH
Panasonic Heating & Ventilation Air-conditioning Europe
 Hagenauer Strasse 43, 65203 Wiesbaden, Germany